

2 0 2 1
COLLECTION

USATE LE BUONE MANIGLIE



Progettare
e costruire in Italia
le maniglie
più belle al mondo.

Designing and
manufacturing in Italy
the most beautiful
handles in the world.

A Family Company.

sempre vicini a te

Proprio come una famiglia accudisce i suoi membri con amore e dedizione, così Colombo Design cura i suoi prodotti, con gli stessi valori e le medesime tradizioni, per fare di ogni ambiente una casa, senza scendere mai a compromessi sull'autenticità. Un manifesto contemporaneo dell'essere creativi, curiosi e sperimentali.

handles with care

Just like a family that handles its members with love and care, Colombo Design cares about its family of products and its production with the same values and traditions to make of any place a home, never accepting any compromise to quality and function, individuality and authenticity. Bonding heritage with creativity, curiosity and innovation.

Mission.

la qualità sensibile

Intraprendere un'impresa nel terzo millennio.

Infondere entusiasmo ai collaboratori, convinti che il fattore umano sia condizione essenziale al progresso aziendale.

Produrre secondo criteri di eccellenza nelle varie fasi di lavorazione per offrire prodotti garantiti.

Rinnovare costantemente impianti e procedure per precedere i rischi dell'obsolescenza. Questi i requisiti di Colombo Design, leader mondiale nella produzione di maniglie, presente in 93 paesi nel mondo attraverso una fitta rete di agenti e distributori. Una realtà solida, nata nel 1991, che si estende su una superficie di 100.000 mq, di cui 25.000 mq coperti, a Terno d'Isola in provincia di Bergamo.

discerning quality

Creating a business in the third millenium.

Motivating staff by recognising that human resources are essential to the company development.

Achieving manufacturing excellence at every stage of production so that products may be guaranteed.

Continuously updating machinery and manufacturing procedures in order to maintain quality levels in harmony with our environment. These are core principles of Colombo Design, world leader in the production of door handles, present in 93 countries worldwide through an extensive network of agents and distributors. A solid reality, founded in 1991, based in Terno d'Isola, in the province of Bergamo, with an area of 100,000 square meters, of which 25,000 sqm are covered.

Network.

factory

BERGAMO - ITALY

distributors

ARGENTINA
ARMENIA
AUSTRALIA
AUSTRIA
AZERBAIJAN
BAHRAIN
BELARUS
BELGIUM
BENIN
BOSNIA and HERZEGOVINA
BRAZIL
BULGARIA
CANADA
CHILE
CHINA
COLOMBIA
CROATIA
CYPRUS
CZECH REPUBLIC

DENMARK
ECUADOR
EGYPT
ESTONIA
FINLAND
FRANCE
GEORGIA
GERMANY
GREECE
HONG KONG
HUNGARY
ICELAND
INDIA
INDONESIA
IRAN
IRAQ
IRELAND
ISRAEL
IVORY COAST

JAPAN
JORDAN
KAZAKHSTAN
KENYA
KYRGYZSTAN
KUWAIT
LATVIA
LEBANON
LIBYA
LITHUANIA
MACEDONIA
MALAYSIA
MALTA
MEXICO
MOLDOVA
MONACO
MONTENEGRO
MOROCCO
NETHERLANDS

NEW CALEDONIA
NEW ZEALAND
NIGERIA
OMAN
PAKISTAN
PANAMA
PHILIPPINES
POLAND
PORTUGAL
PUERTO RICO
QATAR
ROMANIA
RUSSIA
SAUDI ARABIA
SENEGAL
SERBIA
SINGAPORE
SLOVAKIA
SLOVENIA

SOUTH AFRICA
SOUTH KOREA
SPAIN
SWEDEN
SWITZERLAND
SYRIA
THAILAND
TUNISIA
TURKEY
UAE
UKRAINE
UNITED KINGDOM
USA
UZBEKISTAN
VENEZUELA
VIETNAM
ZIMBABWE

Environmental approach.



Lo sviluppo è sostenibile se soddisfa i bisogni delle generazioni presenti senza compromettere le possibilità per le generazioni future di soddisfare i propri bisogni.

(Brundtland Report, United Nations, 1987)

è tempo di green made

Green Made significa pensare, progettare e produrre in armonia con l'ambiente.

Green Made: perché In una economia globale assume un ruolo sempre più importante la protezione delle risorse disponibili ed in particolare lo studio degli aspetti ambientali legati alle diverse attività produttive. L'aumento dei consumi delle risorse non rinnovabili (i minerali ed i metalli come pure i combustibili fossili), dovuto alla costante crescita della popolazione mondiale, impone standards di produzione che privilegino la conservazione delle risorse disponibili. I nostri processi produttivi sono frutto di una globale attenzione alla tutela dell'ambiente.

La gestione accurata di questi processi ha portato, tra le altre cose, all'ottenimento della certificazione UNI EN ISO 14001 «Sistema di gestione ambientale certificato».

Green Made: il valore Ogni singola fase di progettazione e produzione è attentamente analizzata sotto il profilo dell'impatto ambientale ed ogni scelta successiva dettata dal raggiungimento degli obiettivi di eco compatibilità. Così durante la produzione vera e propria, saranno le più avanzate tecnologie appositamente sviluppate ed i più severi controlli, effettuati da personale qualificato, a garantire Green Made by Colombo Design: un prodotto nato con il pensiero costantemente rivolto all'ambiente.

Sustainable development is development that meets the needs of the present without compromising the ability of future generations to meet their own needs.

(Brundtland Report, United Nations, 1987)

it's green made time

«Green made» means thinking, developing and manufacturing in harmony with our environment.

Green Made: why Protecting our resources is more and more important in a global economy, and in particular paying attention to reflections of manufacturing onto the environment. Increase of consumptions of non-renewable resources (minerals, metals and fossil combustibles) due to increase of population, imposes manufacturing standards which privilege conservation of the available resources and raw materials. Our production processes are the result of a total attention to environmental protection. By the accurate management of these processes we obtained the UNI EN ISO 14001 certification «Certified environmental management system».

Green Made: values Each design and production step is carefully checked with regards to the environmental impact and each following decision is taken if our eco-compatibility objectives are fully reached. This means that when we manufacture our products, the Green Made concept by Colombo Design will be guaranteed by the advanced technologies and very strict controls carried out by a very highly qualified personnel, generating a product conceived constantly thinking of the environment.

Certifications.



UNI EN ISO 9001

Sistema di gestione certificato da ICIM

Questa certificazione è valida per il seguente campo applicativo:
Progettazione e fabbricazione di maniglie, complementi per arredamento e di accessori per l'arredo del bagno in materiali non ferrosi.

Certified management system by ICIM

This certification is valid for the following application field:
Design and manufacture of handles, furniture coordinated accessories and bathroom furniture accessories in non-ferrous materials.



UNI EN ISO 14001

Sistema di gestione certificato da ICIM

Questa certificazione è valida per il seguente campo applicativo:
Progettazione e fabbricazione di maniglie e complementi per arredamento in materiale non ferroso, accessori per l'arredo del bagno mediante le fasi di: pressofusione, burattatura, pulitura, galvanica, verniciatura, assemblaggio, confezionamento ed immagazzinamento.

Certified management system by ICIM

This certification is valid for the following application field:
Design and manufacture of non-ferrous handles and coordinated furniture accessories, bathroom furniture accessories by: die-casting, tumble finishing, polishing, electroplating, varnishing, assembling, packing and storing.



UNI EN 1906:2012

Nuova certificazione europea per le maniglie

La norma Europea UNI EN 1906:2012 stabilisce requisiti e metodi di prova per maniglie e pomoli.
Colombo Design ha conseguito, per tutti i suoi modelli, lusinghieri risultati tra i quali il più significativo è il "Grado 4" per la categoria d'uso: sinonimo di assoluta qualità e resistenza.

New European certification for door furniture

The European standard UNI EN 1906:2012 establishes requirements and test methods for lever handles and knobs. Colombo Design achieved, for all of its models, excellent results between which the most significant is the "Grade 4" for the category of use: synonym of absolute quality and resistance.

Warranties.



trattamento di protezione garantito 30 anni

Quello utilizzato da Colombo Design è un processo di finitura mutuato dal settore dell'utensileria, in cui caratteristiche fisiche e meccaniche sono studiate per garantire prestazioni eccezionali di resistenza all'usura meccanica e al decadimento dovuto ad agenti ambientali e chimici. Il processo è stato messo a punto per garantire un notevole aspetto estetico, trasparenza e lucentezza, che fanno risaltare il design del prodotto. Tutti i prodotti trattati con il processo PVD, vengono preventivamente rivestiti con strati di rame, nichel e cromo per garantire un perfetto isolamento della materia prima sottostante. Trattamento con la garanzia di "30 anni" sulle finiture **Zirconium Gold, Oromat, Zirconium Stainless-Steel, Vintage, Vintage Mat, Grafite e Grafite Mat.**



trattamento di protezione garantito 10 anni

La lunga esperienza maturata nel settore dei trattamenti galvanici e PVD, unita alla scelta di prestare particolare attenzione alla qualità nei processi produttivi, consentono a Colombo Design di garantire le finiture dei suoi prodotti oltre la normale copertura prevista dalla legge. È quindi con particolare orgoglio che offriamo ai nostri utenti la garanzia di "10 anni" sulle finiture **Oroplus, Cromo, Cromat, Biancomat e Neromat.** Questo impegno di durata nel tempo del prodotto è la nostra forte ed alternativa risposta al consumismo «usa e getta», sinonimo di spreco ambientale e nemico della memoria collettiva, irrinunciabile valore di tutte le società.

treatment protection guaranteed 30 years

Colombo Design uses a finishing process borrowed from the tools industry, where physical and mechanic features wear have to guarantee a very high performance as far as mechanic wear and decay due to environmental and chemical agents are concerned. This finishing process also guarantees a high level of design where transparency and brightness allow the product to reveal. All PVD-treated products with High Protection System finishing are previously coated with layers of copper, nickel and chrome in order to guarantee the perfect insulation of the underlying raw material. Treatment with warranty of "30 years" on **HPS Zirconium Gold, Matt Gold, HPS/I Zirconium Stainless-Steel, Vintage, Vintage Mat, Graphite and Matt Graphite** finishing.

treatment protection guaranteed 10 years

The long experience in the field of galvanic treatments, combined with the choice to pay special attention to the quality in production processes, enable Colombo Design to ensure the finishes of its products beyond the normal warranty provided by law. It is therefore with great pleasure, we offer to our end-users the warranty of "10 years" on **Oroplus, Chrome, Matt chrome, Matt white and Matt black** finishings. This commitment of product durability is our strong and alternative response to consumerism «disposable», synonymous with environmental waste and enemy of collective memory, an essential value of all societies.

Innovations.



SIX MILLIMETERS CONCEPT

Maniglie con rosetta e bocchetta bassa che non necessitano di lavorazioni aggiuntive sulla porta.

Handles with slim rose and escutcheon. They don't need additional installation works on the door.



ROBOTECH®

Robotech® contraddistingue una gamma di prodotti realizzata utilizzando alta tecnologia e massima automazione per ottenere eccellenza qualitativa e commerciale.

Robotech® is our mark for those products manufactured using high technologies and ultimate automation, to create quality and trading excellence.



CASA SICURA

La soluzione per vivere in una casa sicura. Se vuoi avere la sicurezza di vivere in un ambiente tranquillo e sereno, affidati al sistema antintrusione di Colombo Design! Il pulsante blocca maniglia ne impedisce la rotazione, di conseguenza i malintenzionati non riusciranno più ad entrare nelle vostre case passando dalle finestre e dalle porte finestre.

SAFE HOUSE

The right solution for a safe house. If you're looking for a safe feeling while being in your home, you should use the Colombo Design Security System! The button locks the handle preventing the rotation, so bad people won't be able to enter your house, not via the doors nor the windows.

Materials, Galvanic Treatment and Finishings.



materiali

- OTTONE
- CROMALL®

ciclo standard trattamento galvanico

- OTTONE e/o CROMALL®
leghe metalliche con qualità certificata
- strato di pre-rame elettrodeposto
- secondo strato di rame elettrodeposto
- strato livellante di NICHEL elettrodeposto ad altissimo spessore
- strato elettrodeposto OROPLUS, CROMO e CROMAT
- trattamento PVD solo per finiture
HPS ZIRCONIUM GOLD,
HPS ZIRCONIUM STAINLESS-STEEL, OROMAT,
VINTAGE, VINTAGE MAT, GRAFITE e GRAFITE MAT

materials

- SOLID BRASS
- CROMALL®

standard galvanic treatment cycle

- SOLID BRASS and/or CROMALL®
metal alloys of certified quality
- first electroplated copper layer
- second electroplated copper layer
- very high electroplated NICKEL
levelling layer
- electroplated layer OROPLUS, CHROME and MATT CHROME
- PVD treatment applicable only on finishings
HPS ZIRCONIUM GOLD,
HPS ZIRCONIUM STAINLESS-STEEL, MATT GOLD,
VINTAGE, VINTAGE MAT, GRAPHITE and MATT GRAPHITE



Designers.

Ogni cosa è stata disegnata.
Poche cose sono state disegnate bene.

Everything is designed.
Few things are designed well.

ACERBIS, Marco
ANDREA MAFFEI ARCHITECTS
ANGELETTI RUZZA DESIGN
ARCHITETTURA LABORATORIO
BARTOLI DESIGN
BETTONICA, Luta e LEONE, Giancarlo
CASTRIGNANO, Andrea
CLAESSON KOIVISTO RUNE
COLOMBO, Luca
DE LUCCHI, Michele
DI BLASI, Ottavio
GRCIC, Konstantin
HASUIKE, Makio
KIMURA, Tomo
LOHMANN, Birgit
LUCCHESI, Francesco
MASSAUD, Jean Marie
MEDA, Alberto
MESSINEO e SETTIMELLI
CATTANEO, Paolo (■■■■DESIGN)
MORRISON, Jasper
PININFARINA, Paolo
PIO e TITO TOSO lab
PIVA, Marco
RAGNI, Matteo
RONCHI, Mauro
STUDIO KAIROS
STUDIO JEAN-PHILIPPE NUEL
STUDIO SPALVIERI / DEL CIOTTO

Collections.

le collezioni the collections



15 alatò	43 dea	77 fedra	107 lund	137 moon	167 spider MR15	195 tender	227 zelda
19 alba	47 drop	81 flessa	113 madi	141 olly	171 star	199 tool	
23 ama	51 edo	85 gaia	117 mapo	145 pegaso	175 tacta	207 trama LC71	
27 blazer	55 electra	89 gira	121 meta	149 prius	179 tailla	211 trama LC81	
31 bold PT11	61 elle	93 isy	125 milla LC31	153 sirio	183 taipan	215 twitty	
35 bold PT15	67 ellesse	99 lara	129 milla LC41	159 slim	187 talita	219 viola	
39 daytona	73 esprit	103 libra	133 mixa	163 spider MR11	191 tecno	223 wing	

Classic Line



235 cameo
239 heidi
243 ida
247 peter
251 piuma

ROBOTECH®

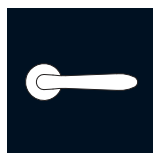

259 mach	287 robocinque
263 robot CD41	291 robocinques
267 robot CD75	
271 robodue	
275 robotre	
279 roboquattro	
283 roboquattros	

pomoli door knobs



298 bold	314 push
300 cut	316 robot
304 daytona	322 robot CD75
306 drop	324 round
308 etro	328 spider
310 mapo	330 square
312 moon	

maniglioni e battenti pulls and door knockers

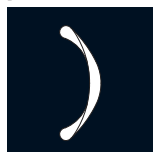

338 daytona	354 roboquattro	370 nice	384 id313-413y
340 elle	356 square	372 piuma	386 id513-613y
342 five	358 tender	374 robot	388 lc113-213y
344 flesso	360 wave	376 cloud	390 lc413-513y
346 logo	362 zen	378 wind	392 cd113 mignon
348 lund	366 blues	380 am113-213y	394 cd213rs
350 noa	368 jazz	382 id113-213y	396/8 flessum/toc-toc

maniglie ad incasso flush handles



402 enter	412 cb111
404 open	414 id411
406 open sq	416 lc111
408 cd111	
408 cd211	
410 cd311	
410 cd511	

programma blindate armored door program

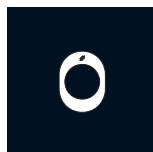

420 mostrine rose plates
424 inserti universal underconstructions
426 pomolini knob sets
428 kit sr sr kit

complementi complements



432 dkzero
436 dispositivi di sicurezza windows security sets
438 dispositivi antieffrazione windows security sets
440 fermaporta door stoppers
442 chiavi keys

444 nottolini toilet roses
446 libero/occupato toilet roses with privacy snibs

appenditutto coat hangers



450 alizé	464 hermitage	478 melò	492 time
452 bart	466 hook 1/2	480 nordic	494 trio
454 basic	468 khala	482 over	
456 basic Q	470 land	484 plus	
458 club	472 link	486 polo	
460 forever	474 look	488 portofino	
462 golf	476 lulù	490 road	

FORMAE®



498 maniglie per mobile furniture handles
524 pomoli per mobile furniture knobs

2021 EDITION

Le Collezioni

The Collections

MADE IN ITALY



ALATÓ

STUDIO JEAN-PHILIPPE NUEL

ALATÒ

JP 11 Design:
Studio Jean-Philippe Nuel



CR
Cromo
Chrome



GL
Grafite
Graphite



CM
Cromat
Matt chrome



GM
Grafite Mat
Matt graphite

JP 11 R-RY Ø50

JP 19 BZG Ø50

JP 12 IM

JP 12 DK/SM

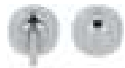

CR - CM - GL - GM

CR - CM - GL - GM

CR - CM - GL - GM

CR - CM - GL - GM

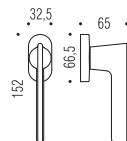
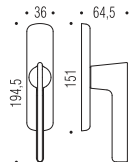
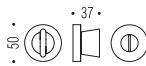
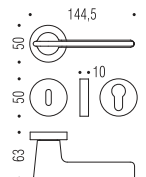



Materiale: Ottone
Material: Brass





158

ALBA

LUCA COLOMBO

ALBA

LC 91 Design:
Luca Colombo



CR/CM
Cromo/Cromat
Chrome/Matt chrome



GL/GM
Grafite/Grafite Mat
Graphite/Matt graphite

LC 91 R-RY 50x50

FF 29 BZG 50x50

LC 92 IM

LC 92 DK/SM



CR/CM - GL/GM

CM - GM

CR/CM - GL/GM

CR/CM - GL/GM

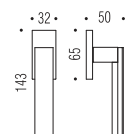
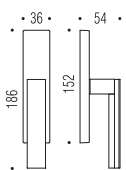
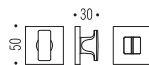
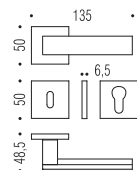



Materiale: Ottone/Cromall®
Material: Brass/Cromall®





AMMA

ANDREA MAFFEI ARCHITECTS

MM

MF 11 Design:
Andrea Maffei Architects



CR
Cromo
Chrome



GL
Grafite
Graphite



CM
Cromat
Matt chrome



GM
Grafite Mat
Matt graphite

DKZERO

MF 11 R-RY Ø50

MF 19 BZG Ø50

MF 12 IM

MF 12 DK/SM

MF 12 DK0/SM



CR - CM - GL - GM

CR - CM - GL - GM

CR - CM - GL - GM

CR - CM - GL - GM

CR - CM - GM

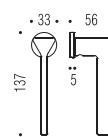
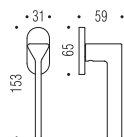
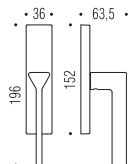
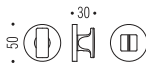
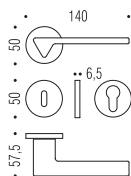



Materiale: Ottone
Material: Brass





BLAZER

FRANCESCO LUCCHESI

BLAZER

FL 11 Design:
Francesco Lucchese



HPS
Zirconium Gold



HPS/1
Zirconium
Stainless-steel



OL
Oroplus



CM
Cromat
Matt chrome

FL 11 R-RY Ø50

CD 49 BZG G Ø50

FL 12 IM

FL 12 DK/SM



HPS - OL - HPS/1 - CM

HPS - OL - HPS/1 - CM

HPS - OL - HPS/1 - CM

HPS - OL - HPS/1 - CM

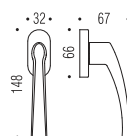
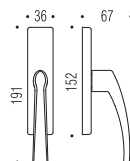
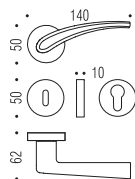



Materiale: Ottone
Material: Brass



Il tuo è un pezzo che sta lì
in attesa di essere usato.
Ma se ogni cosa ha un
suo tempo, anche tu hai il tuo.
E quando arriva il momento
di usarla, non la senti più
come un oggetto, ma come
un amico che ti aspetta.
E allora, non la senti più
come un oggetto, ma come
un amico che ti aspetta.

3
2
1
0



BOLD

PIO E TITO TOSO LAB

BOLD

PT 11 Design:
Pio e Tito Toso lab



CR
Cromo
Chrome



CM
Cromat
Matt chrome

PT 11 R-RY 52x52

PT 19 BZG 52x52

PT 12 IM

PT 12 DK/SM



CR - CM

CR - CM

CR - CM

CR - CM

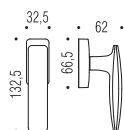
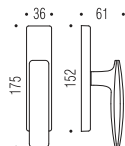
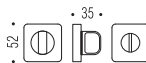
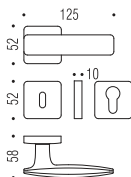

Materiale: Ottone
Material: Brass



PRIMA GARANTIA 10 ANNI
10
CORRISPONDING 10 YEARS WARRANTY



A scuola



BOLD

PIO E TITO TOSO LAB

BOLD

PT 15 Design:
Pio e Tito Toso lab



CR
Cromo
Chrome



CM
Cromat
Matt chrome

PT 15 R-RY 52x52

PT 19 BZG 52x52



CR - CM

CR - CM

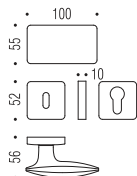

Materiale: Ottone
Material: Brass

10
• PRIMA GARANTIA 10 ANNI •
• 10 YEARS WARRANTY •





DAYTONA

pininfarina

DAYTONA

PF 11 Design: *pininfarina*



OL
Oroplus



CM
Cromat
Matt chrome

PF 11 R-RY Ø50

CD 69 BZG G Ø50

PF 12 IM

PF 12 DK/SM



OL - CM

OL - CM

OL - CM

OL - CM

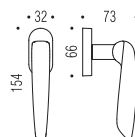
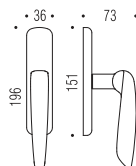
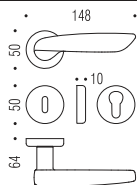



Materiale: Ottone
Material: Brass





DEA

PIO E TITO TOSO LAB

DEA

FF 21 Design:
Pio e Tito Toso lab



CR
Cromo
Chrome



CM
Cromat
Matt chrome

DKZERO

FF 21 R-RY 50x50

FF 29 BZG 50x50

FF 22 IM

FF 22 DK/SM

FF 22 DK0/SM



CR - CM

CR - CM

CR - CM

CR - CM

CR - CM

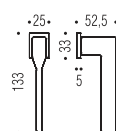
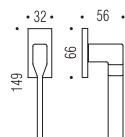
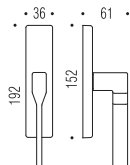
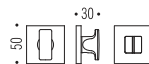
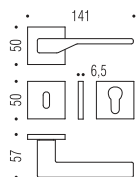



Materiale: Ottone
Material: Brass



DROP

LUCA COLOMBO

DROP

LC 45 Design:
Luca Colombo



HPS
Zirconium Gold



CM
Cromat
Matt chrome



CR
Cromo
Chrome



BR
Bronzo
Bronze

LC 45 R-RY Ø50

CD 49 BZG G Ø50



HPS - CR - CM - BR

HPS - CR - CM - BR

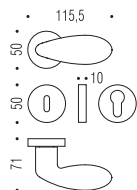

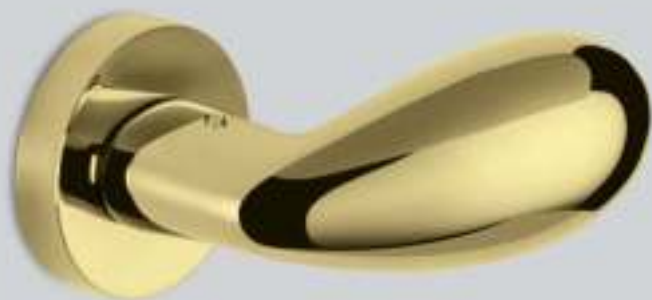

Materiale: Ottone
Material: Brass





EDO

MAKIO HASUIKE

EDO

MH 11 Design:
Makio Hasuike



OL
Oroplus



CM
Cromat
Matt chrome

MH 11 R-RY Ø50

CD 49 BZG G Ø50

MH 12 IM

MH 12 DK/SM



OL - CM

OL - CM

OL - CM

OL - CM

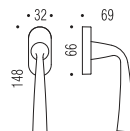
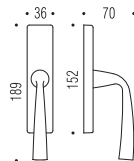
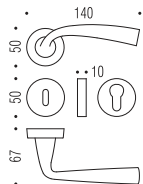



Materiale: Ottone
Material: Brass





Numero 12 1992

Numero 12 1992

ELECTRA

MESSINEO E SETTIMELLI

ELECTRA

MS 11 Design:
Messineo e Settimelli



CR
Cromo
Chrome



VL
Vintage



CM
Cromat
Matt chrome



VM
Vintage Mat



NM RAL 9005
Neromat
Matt Black

MS 11 R-RY 50x50

FF 29 BZG 50x50

MS 12 IM

MS 12 DK/SM



CR - CM - VL - VM - NM

CR - CM - VL - VM - NM

CR - CM - VL - VM - NM

CR - CM - VL - VM - NM

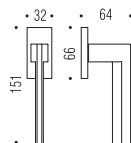
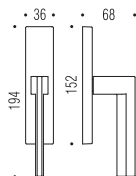
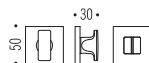
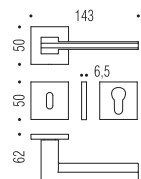



Materiale: Cromall®
Material: Cromall®



Un buon
oggetto
di design
è per
sempre.

Good
design
is
forever.

Van Day Truex



ELLE

BARTOLI DESIGN

ELLE

BD 11 Design:
Bartoli Design



CR
Cromo
Chrome



GL
Grafite
Graphite



CM
Cromat
Matt chrome



GM
Grafite Mat
Matt graphite

BD 11 R-RY Ø50

CD 49 BZG G Ø50

BD 12 IM

BD 12 DK/SM



CR - CM - GL - GM

CR - CM - GL - GM

CR - CM - GL - GM

CR - CM - GL - GM

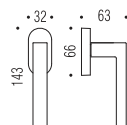
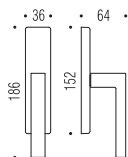
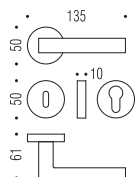



Materiale: Cromall®
Material: Cromall®



ELLE

BD 11 Design:
Bartoli Design



CR
Cromo
Chrome



CM
Cromat
Matt chrome

BD 11 RF-RYF Ø50

FF 19 BZG Ø50

BD 12 DKF/SM



CR - CM

CR - CM

CR - CM

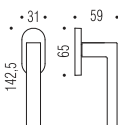
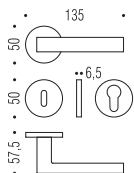



Materiale: Cromall®
Material: Cromall®



HUMAN
FIGURE



SIMBOLO DELLA PROCREAZIONE
SYMBOL OF PROCREATION

testo di creare la vita.

PER INFORMAZIONI
E MAGGIORE

ELLESE

BARTOLI DESIGN

ELLESSE

BD 21 Design:
Bartoli Design



CR
Cromo
Chrome



GL
Grafite
Graphite



CM
Cromat
Matt chrome



GM
Grafite Mat
Matt graphite

BD 21 R-RY 52x52



CR - CM - GL - GM

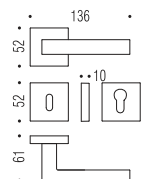

MM 29 BZG 52x52



CR - CM - GL - GM



BD 12 IM



CR - CM - GL - GM

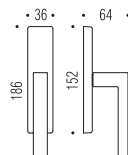

BD 22 DK/SM



CR - CM - GL - GM

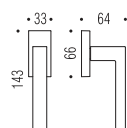



Materiale: Cromall®
Material: Cromall®



ELLESSE

BD 21 Design:
Bartoli Design



CR
Cromo
Chrome



CM
Cromat
Matt chrome

BD 21 RF-RYF 50x50

FF 29 BZG 50x50

BD 22 DKF/SM



CR - CM

CR - CM

CR - CM

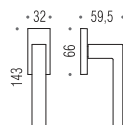
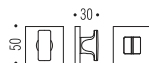
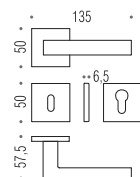



Materiale: Cromall®
Material: Cromall®



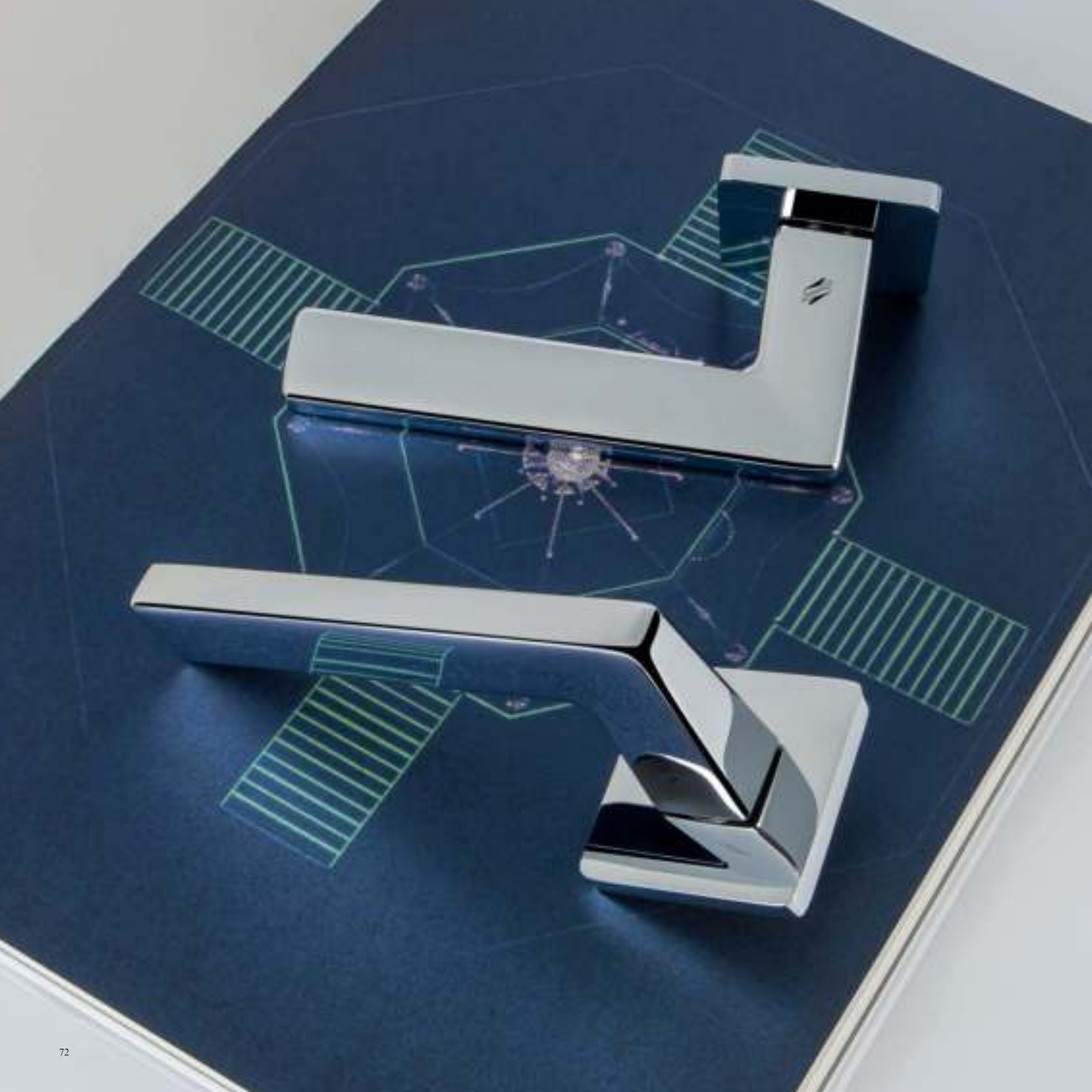

ESPRIT

BIRGIT LOHMANN

ESPRIT

BT 11 Design:
Birgit Lohmann



CR
Cromo
Chrome



HPS/1
Zirconium
Stainless-steel



CM
Cromat
Matt chrome

BT 11 R-RY 50x50

BT 19 BZG 50x50

BT 12 IM

BT 12 DK/SM



HPS/1 - CR - CM

HPS/1 - CR - CM

HPS/1 - CR - CM

HPS/1 - CR - CM

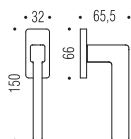
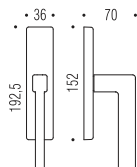
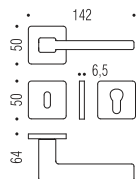



Materiale: Ottone
Material: Brass



Due alberi pe



...anti.
...paucite.
L'na albero
al centro della stanza
deserta.
Senza soffitto.
Accanto al grande albero
falso.
L'uomo ricorda.
Adesso
la voce di un solo bimbo.
L'albero è un giorno
non finito.
Anche le palline di vetro
sfumavano
tra le dita del bimbo.
Era una risata

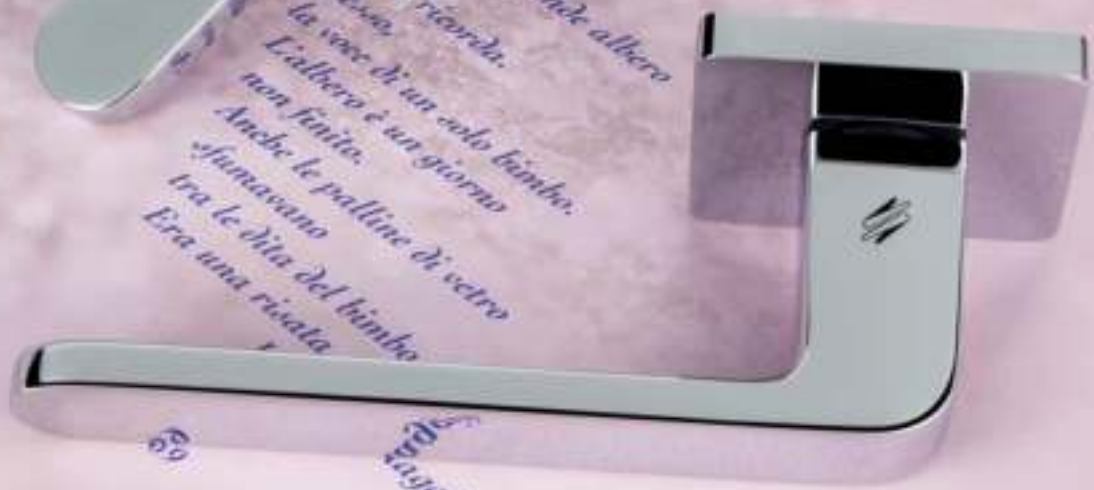

69

...ardi
...scuggia.

FEDRA

ANDREA CASTRIGNANO

FEDRA

AC 11 Design:
Andrea Castrignano



OL
Oroplus



VL
Vintage



CR
Cromo
Chrome



VM
Vintage Mat



CM
Cromat
Matt chrome

AC 11 R-RY 50x50

BT 19 BZG 50x50

AC 12 IM

AC 12 DK/SM



OL - CR - CM - VL - VM

OL - CR - CM - VL - VM

OL - CR - CM - VL - VM

OL - CR - CM - VL - VM

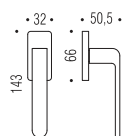
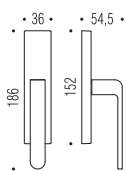
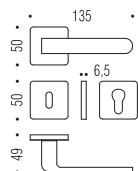



Materiale: Ottone
Material: Brass





FLESSA

CARLO BARTOLI

FLESSA

CB 51 Design:
Carlo Bartoli



HPS
Zirconium Gold



CM
Cromat
Matt chrome



OL
Oroplus



NI
Nikelmat
Matt nickel

CB 51 R-RY Ø50

CD 49 BZG G Ø50

CB 52 M

CB 52 DK/SM DX-SX



HPS - OL - CM - NI

HPS - OL - CM - NI

HPS - OL - CM - NI

HPS - OL - CM - NI

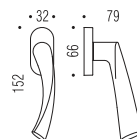
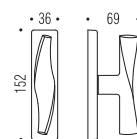
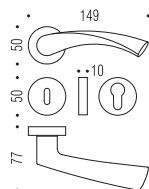



Materiale: Ottone
Material: Brass





GAIA

GIULIO RIPAMONTI

GAIA

GR 11 Design:
Giulio Ripamonti



OL
Oroplus



CM
Cromat
Matt chrome



CR
Cromo
Chrome

GR 11 R-RY Ø50

CD 49 BZG G Ø50

GR 12 IM

GR 12 DK/SM



OL - CR - CM

OL - CR - CM

OL - CR - CM

OL - CR - CM

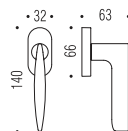
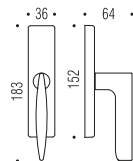
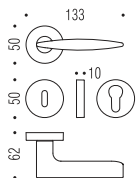



Materiale: Ottone
Material: Brass



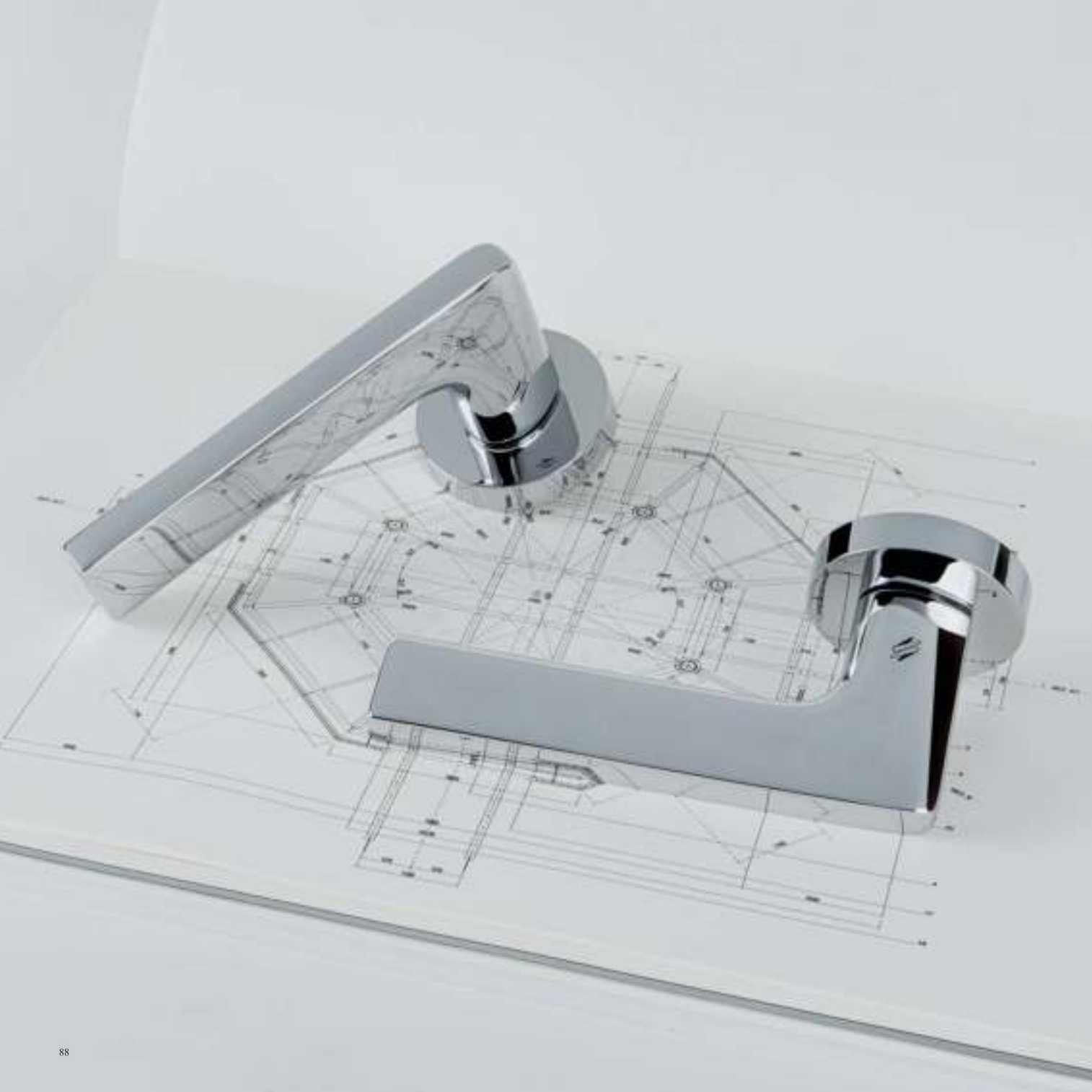

GIRA

JASPER MORRISON

GIRA

JM 11 Design:
Jasper Morrison



OL
Oroplus



HPS/1
Zirconium
Stainless-steel



CR
Cromo
Chrome



VL
Vintage



CM
Cromat
Matt chrome



VM
Vintage Mat

DKZERO

JM 11 R-RY Ø50

CD 49 BZG G Ø50

JM 12 IM

JM 12 DK/SM

JM 12 DK0/SM



OL-HPS/1-CR-CM-VL-VM

OL-HPS/1-CR-CM-VL-VM

OL-HPS/1-CR-CM-VL-VM

OL-HPS/1-CR-CM-VL-VM

OL - CR - CM - VM

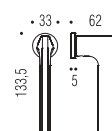
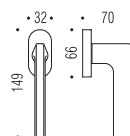
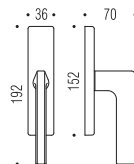
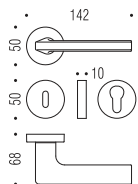



Materiale: Ottone
Material: Brass





194

LUTA BETTONICA E GIANCARLO LEONE

ISY

BL 11 Design:
Luta Bettonica e Giancarlo Leone



CR
Cromo
Chrome



CM
Cromat
Matt chrome

DKZERO

BL 11 R-RY 52x52



CR - CM

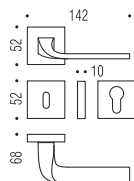

MM 29 BZG 52x52



CR - CM

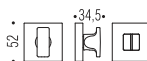

BL 12 IM



CR - CM

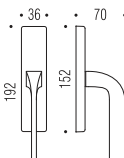

BL 12 DK/SM



CR - CM

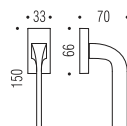

BL 12 DK0/SM



CR - CM

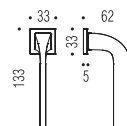



Materiale: Ottone
Material: Brass



ISY

BL 11 Design:
Luta Bettonica e Giancarlo Leone



CR
Cromo
Chrome



CM
Cromat
Matt chrome

DKZERO

BL 11 RF-RYF 50x50

FF 29 BZG 50x50

BL 12 DKF/SM

BL 12 DK0/SM



CR - CM

CR - CM

CR - CM

CR - CM

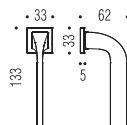
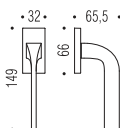
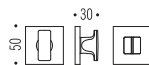
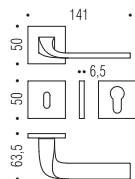



Materiale: Ottone
Material: Brass





LARA

CARLO BARTOLI

LARA

CB 71 Design:
Carlo Bartoli



HPS
Zirconium Gold



CM
Cromat
Matt chrome



OL
Oroplus



NI
Nikelmat
Matt nickel



OM
Oromat
Matt gold

CB 71 R-RY Ø50

CD 49 BZG G Ø50

CB 72 IM

CB 72 DK/SM



HPS - OL - OM - CM - NI

HPS - OL - OM - CM - NI

HPS - OL - OM - CM - NI

HPS - OL - OM - CM - NI

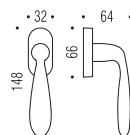
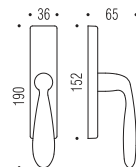
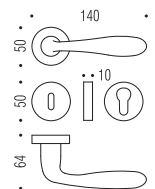

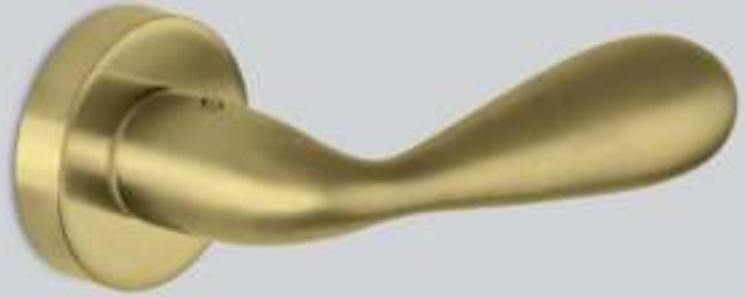

Materiale: Ottone
Material: Brass





LIBRA

STUDIO KAIROS

LIBRA

SK 21 Design:
Studio Kairos



OL
Oroplus



CR
Cromo
Chrome

SK 21 R-RY Ø50

CD 49 BZG G Ø50

SK 22 M

SK 22 DK/SM



OL - CR

OL - CR

OL - CR

OL - CR

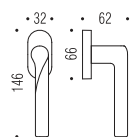
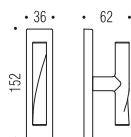
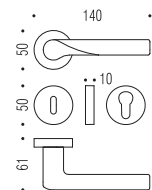



Materiale: Ottone
Material: Brass



sensazioni urbanistiche e cronologiche. E
dinanzi ai miei quadri cronologici, come avete
in grado di dare espressione alle forme
che dinanzi ai miei dipinti piange come avete
che dinanzi ai miei dipinti, allora vi sfugge l'essenzialità
compio quando li dipingo. E quando vi sfugge l'essenzialità
dei loro rapporti cromatici, allora vi sfugge il momento
per paura di essere catalogato in modo occasionale
riferiva di essere catalogato in modo occasionale
che il colore fosse per lui un mezzo espressivo, come
c'è più una linea, disse a Elaine De Kooning
potrebbe ancora dipingere?». E in un'altra occasione
soprattutto un mezzo. I mezzi di rappresentazione
solamente un sistema per comunicare, quindi le campiture
per lui, le estensioni cromatiche, quindi le campiture
che si tramutava in un sistema per comunicare, quindi le campiture
forbido fu sempre più rosso, giallo e nero. Nel
inspiegava meno toni rosso, giallo e nero. Nel
come mattoni, grigio, blu scuro e nero. Nel
nella Sidney Janis Gallery (ottobre 1958), i dipinti
necessità, più scuri e misteriosi.



LUND

CLAESSON KOIVISTO RUNE

LUND

SE 11 Design:
Claesson Koivisto Rune



CR
Cromo
Chrome



GL
Grafite
Graphite



CM
Cromat
Matt chrome



GM
Grafite Mat
Matt graphite

SE 11 R-RY Ø50

SE 19 BZG Ø50

SE 12 IM

SE 12 DK/SM



CR - CM - GL - GM

CR - CM - GL - GM

CR - CM - GL - GM

CR - CM - GL - GM

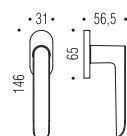
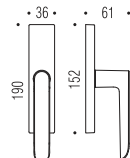
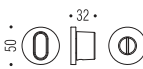
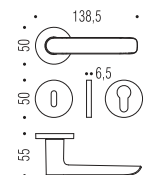



Materiale: Ottone
Material: Brass



Il design
è il nucleo
centrale
di una
creazione
umana.

Design
is the
fundamental
soul of a
human-made
creation.

Steve Jobs



Mappe
Mappe 01

- 01
- 02
- 03
- 04
- 05
- 06
- 07
- 08
- 09
- 10
- 11
- 12
- 13
- 14
- 15
- 16
- 17
- 18
- 19
- 20
- 21
- 22
- 23
- 24
- 25
- 26
- 27
- 28
- 29

Legenda
Legend

MADI

ALBERTO MEDA

MADI

AM 31 Design:
Alberto Meda

A
Selezione d'onore
Compasso d'Oro
ADI 1998



OL
Oroplus



CM
Cromat
Matt chrome



OM
Oromat
Matt gold

AM 31 R-RY Ø50

CD 49 BZG G Ø50

AM 32 M

AM 32 DK/SM DX-SX



OL - OM - CM

OL - OM - CM

OL - OM - CM

OL - OM - CM

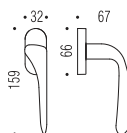
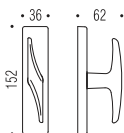
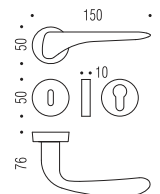

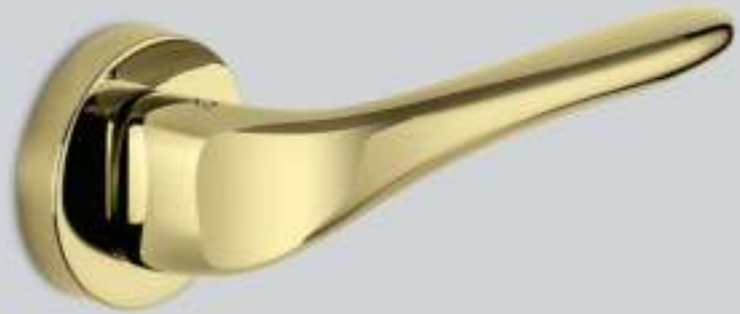

Materiale: Ottone
Material: Brass



Le tracce del Maestro The Traces of the Master

Kinue Horikawa

Gli schizzi di Angelo Mangiarotti sorpresero all'origine di ogni progetto di design o un'opera di scultura - ha traccia precoce delle sue prime intuizioni a qualunque genere di realizzazione reultò perfettamente congruenti con quelle ancora più che le fotografie dei schizzi a rivelare fedelmente l'affinato gusto che ha ispirato l'idea stessa dell'opera. Fatalmente, nel corso della sua realtà subiva una serie di modifiche attribuite a committenza, a motivi economici o a questa o quella recente opera di Augusto. Ma subito anche modifiche in fase di montaggio, la stretta vicinanza tra loro prime intuizioni abbozzate negli schizzi non essere acritico all'eccellenza voluta, in ogni situazione. Mangiarotti prevedendo chiaramente un profilo di per non snaturare il progetto originario. Gli schizzi dei progetti architettonici e i disegni, ma rivelano altresì un'attenzione ai dettagli e per la modalità di costruzione della fabbrica. In ogni occasione, a volte dedicava la propria attenzione in modo concentrato con la maggiore esattezza per un'idea per realizzarlo con la massima linea curva, tracciata con apparente non meno gli schizzi degli oggetti di design e della realtà tecnicamente possibile la loro realizzazione all'atto pratico eseguita con tutta la cura e l'attenzione dei materiali adoperati. Si tratta di una scelta logica si giustifica anche in termini di compatibilità con gli abbozzamenti e il calcolo all'istante, in modo tale da poter realizzare un'opera un'identità unica.

Per Augusto Mangiarotti gli schizzi erano



M A P O

MAURO RONCHI

MAPO

RM 15 Design:
Mauro Ronchi



CR
Cromo
Chrome



CM
Cromat
Matt chrome



NM RAL 9005
Neromat
Matt Black

RM 15 R-RY Ø50

CD 49 BZG G Ø50



CR - CM - NM

CR - CM - NM

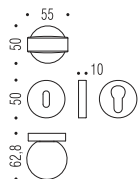



Materiale: Ottone
Material: Brass





META

KONSTANTIN GRČIĆ

META

KG 11 Design:
Konstantin Grcic



CR
Cromo
Chrome



CM
Cromat
Matt chrome

KG 11 R-RY Ø50



CR - CM

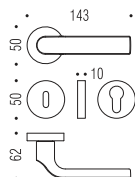

CD 49 BZG G Ø50



CR - CM



KG 12 IM



CR - CM

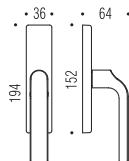

KG 12 DK/SM



CR - CM

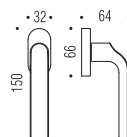



Materiale: Ottone
Material: Brass





MILLA

LUCA COLOMBO

MILLA

LC 31 Design:
Luca Colombo



OL/OM
Oroplus/Oromat
Oroplus/Matt gold



CR/CM
Cromo/Cromat
Chrome/Matt chrome

LC 31 R-RY Ø50

CD 49 BZG G Ø50

LC 32 IM

LC 32 DK/SM



OL/OM - CR/CM

OM - CM

OL/OM - CR/CM

OL/OM - CR/CM

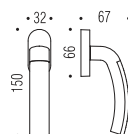
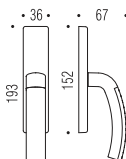
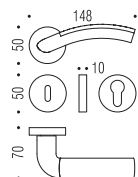



Materiale: Cromall®
Material: Cromall®

PRIMA GARANTIA 10 ANNI
10
CORRISPONDING 10 YEARS WARRANTY





15 km di circuiti
ciclopeditoni

15 kilometers
of bicycle and
pedestrian circuits

Parco Media Valle del Lambro

Progetto architettonico
di Gianfrancesco
Pavesi e
Tommaso
Bianchi

MILLA

LUCA COLOMBO

MILLA

LC 41 Design:
Luca Colombo



OL/OM
Oroplus/Oromat
Oroplus/Matt gold



CR/CM
Cromo/Cromat
Chrome/Matt chrome

LC 41 R-RY Ø50

CD 49 BZG G Ø50

LC 42 IM

LC 42 DK/SM



OL/OM - CR/CM

OM - CM

OL/OM - CR/CM

OL/OM - CR/CM

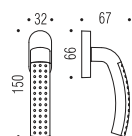
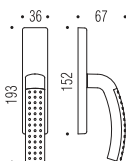
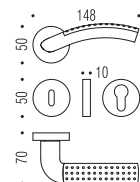



Materiale: Cromall®
Material: Cromall®

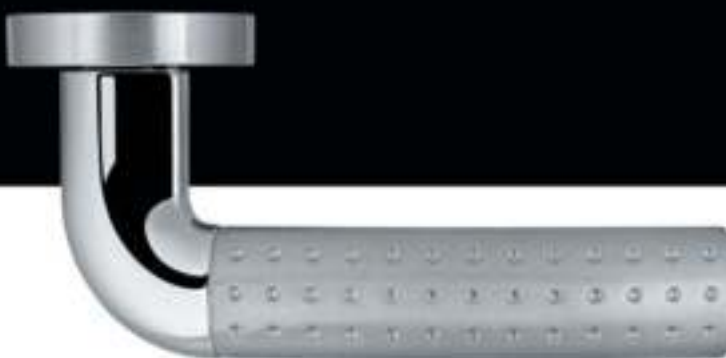



OMICO
TERMINO

...e non è solo questo. Nel mondo del design
c'è una grande attenzione per i materiali e
per le forme. In questo senso, il design è
una disciplina che si occupa di creare
oggetti che siano funzionali e che
abbiano una bellezza intrinseca. È
questo il ruolo del design: creare
oggetti che siano utili e che
abbiano una bellezza intrinseca.

MIXA

CARLO BARTOLI

MIXA

CB 21 Design:
Carlo Bartoli



OL/OM
Oroplus/Oromat
Oroplus/Matt gold



CR/CM
Cromo/Cromat
Chrome/Matt chrome

CB 21 R-RY Ø50

CD 49 BZG G Ø50

CB 22 M

CB 22 DK/SM DX-SX



OL/OM - CR/CM

OL - CM

OL/OM - CR/CM

OL/OM - CR/CM

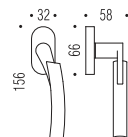
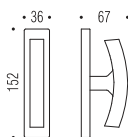
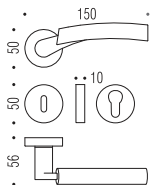



Materiale: Ottone
Material: Brass





MOON

BARTOLI DESIGN

MOON

BD 15 Design:
Bartoli Design



HPS
Zirconium Gold



CM
Cromat
Matt chrome



CR
Cromo
Chrome

BD 15 R-RY Ø50

CD 49 BZG G Ø50



HPS - CR - CM

HPS - CR - CM

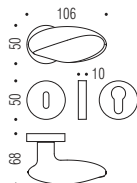



Materiale: Ottone
Material: Brass





OLLY

LUCA COLOMBO

OLLY

LC 61 Design:
Luca Colombo



10 ANNI DI GARANZIA
10 YEARS WARRANTY

OL
Oroplus



10 ANNI DI GARANZIA
10 YEARS WARRANTY

CM
Cromat
Matt chrome



10 ANNI DI GARANZIA
10 YEARS WARRANTY

CR
Cromo
Chrome

LC 61 R-RY Ø50



OL - CR - CM

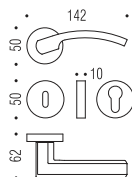

CD 49 BZG G Ø50



OL - CR - CM



LC 62 IM



OL - CR - CM

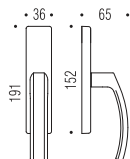

LC 62 DK/SM



OL - CR - CM

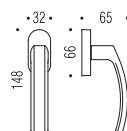



Materiale: Ottone
Material: Brass





PEGASO

ALBERTO MEDA

PEGASO

AM 11 Design:
Alberto Meda



CR
Cromo
Chrome



CM
Cromat
Matt chrome

AM 11 R-RY Ø50

CD 49 BZG G Ø50

AM 12 M

AM 12 DK/SM



CR - CM

CR - CM

CR - CM

CR - CM

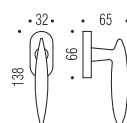
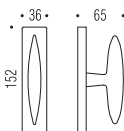
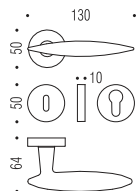



Materiale: Ottone
Material: Brass



子神聖なる
光見河万



PRIUS

MARCO ACERBIS

PRIUS

MA 11 Design: Marco Acerbis

A
 Selezione d'onore
 Compasso d'Oro
 ADI 2008



CR
Cromo
 Chrome



CM
Cromat
 Matt chrome

MA 11 R-RY 52x52



CR - CM

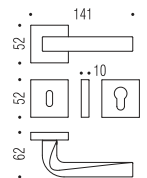

MM 29 BZG 52x52



CR - CM

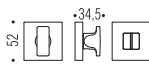

MA 12 IM



CR - CM

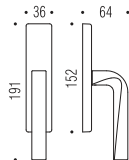

MA 12 DK/SM



CR - CM

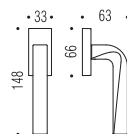



Materiale: Ottone
Material: Brass





SIRIO

COLOMBO DESIGN

SIRIO

CD 11 Design:
Colombo Design



CD 11 R-RY Ø50

CD 69 BZG G Ø50

CD 12 M

CD 12 DK/SM DX-SX



OL - CR - CM

OL - CR - CM

OL - CR - CM

OL - CR - CM

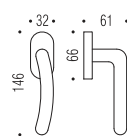
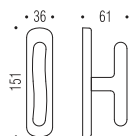
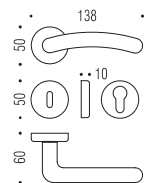



Materiale: Ottone
Material: Brass



Se ritieni che
un buon design
sia costoso,
dovresti
considerare
il costo di un
cattivo design.

If you
think that
good design
is expensive,
you should
look at the cost
of bad design.

Ralf Speth



The Olympia by J.M.W. Turner

SLIM

STUDIO SPALVIERI / DEL CIOTTO

SLIM

FF 11 Design:
Studio Spalvieri / Del Ciotto



CR
Cromo
Chrome



CM
Cromat
Matt chrome

FF 11 R-RY Ø50

FF 19 BZG Ø50

FF 12 IM

FF 12 DK/SM



CR - CM

CR - CM

CR - CM

CR - CM

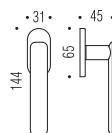
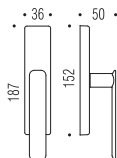
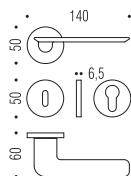



Materiale: Ottone
Material: Brass





SPIDER

MATTEO RAGNI

SPIDER

MR 11 Design: Matteo Ragni



CR
Cromo
Chrome



CM
Cromat
Matt chrome

MR 11 R-RY 51x51

MR 29 BZG G 51x51

MR 12 IM

MR 12 DK/SM



CR - CM

CR - CM

CR - CM

CR - CM

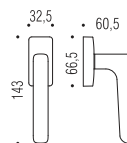
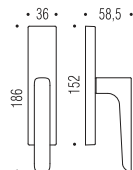
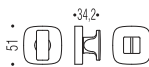
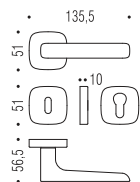



Materiale: Ottone
Material: Brass





SPIDER

MATTEO RAGNI

SPIDER

MR_15 Design:
Matteo Ragni



CR
Cromo
Chrome



CM
Cromat
Matt chrome

MR 15 R-RY 51x51

MR 29 BZG G 51x51



CR - CM

CR - CM

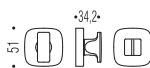
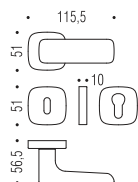



Materiale: Ottone
Material: Brass





STAR

COLOMBO DESIGN

STAR

CD_01 Design:
Colombo Design



CM
Cromat
Matt chrome



NM RAL 9005
Neromat
Matt Black

CD 01 R-RY Ø50

CD 69 BZG G Ø50

CD 02 IM

CD 02 DK/SM



CM - NM

CM - NM

CM - NM

CM - NM

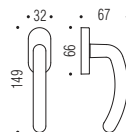
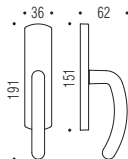
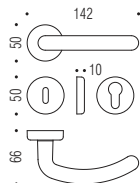



Materiale: Ottone
Material: Brass





TACTA

CARLO BARTOLI

TACTA

CB 11 Design:
Carlo Bartoli



NI/PE
Nikelmat/Pero
Matt nickel/Pear wood



NI/EM
Nikelmat/Ebano makassar
Matt nickel/Makassar ebony

CB 11 R-RY Ø48

CD 39 BZG Ø48

CB 12 IM



NI/PE - NI/EM

NI

NI/PE - NI/EM

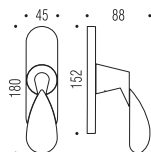
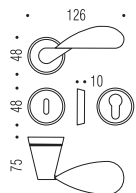

Le differenze di venatura e colore che si riscontrano sul particolare in legno, sono dovute esclusivamente all'utilizzo di masselli
Grain and colour differences you notice on the piece are natural characteristics of the genuine wood

Materiale: Ottone e Legno massello
Material: Brass and genuine wood





TALLA

LUCA COLOMBO

TAILLA

LC 51 Design:
Luca Colombo



OL/OM
Oroplus/Oromat
Oroplus/Matt gold



CR/CM
Cromo/Cromat
Chrome/Matt chrome

LC 51 R-RY Ø50

CD 49 BZG G Ø50

LC 52 IM

LC 52 DK/SM



OL/OM - CR/CM

OL - CR

OL/OM - CR/CM

OL/OM - CR/CM

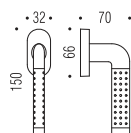
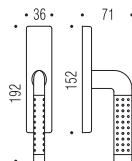
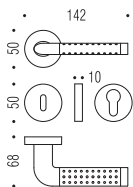



Materiale: Cromall®
Material: Cromall®





they remain high
that icy lea

TAIPAN

LUCA COLOMBO

TAIPAN

LC 11 Design:
Luca Colombo



OL/OM
Oroplus/Oromat
Oroplus/Matt gold



CR/CM
Cromo/Cromat
Chrome/Matt chrome

LC 11 R-RY Ø50

CD 49 BZG G Ø50

LC 12 IM

LC 12 DK/SM

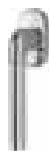

OL/OM - CR/CM

OL - CR

OL/OM - CR/CM

OL/OM - CR/CM

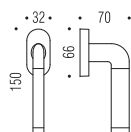
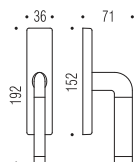
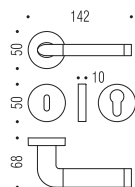



Materiale: Cromall®
Material: Cromall®





TALITA

LUCA COLOMBO

TALITA

LC 21 Design:
Luca Colombo



OL/OM
Oroplus/Oromat
Oroplus/Matt gold



CM/CR
Cromat/Cromo
Matt chrome/Chrome

LC 21 R-RY Ø50

CD 69 BZG G Ø50

LC 22 IM

LC 22 DK/SM



OL/OM - CM/CR

OL - CM

OL/OM - CM/CR

OL/OM - CM/CR

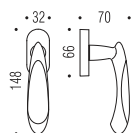
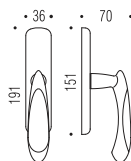
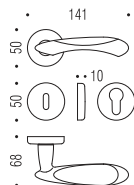

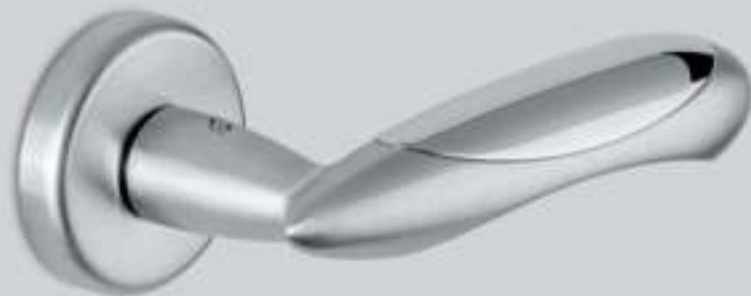

Materiale: Cromall®
Material: Cromall®





TECNO

momaDESIGN

TECNO

MO 11 Design: **mamaDESIGN**



CM/CMQ
Cromat/Carbonium
Matt chrome/Carbonium



CM/CR
Cromat/Cromo
Matt chrome/Chrome

MO 11 R-RY 50x50

BT 19 BZG 50x50

MO 12 IM

MO 12 DK/SM



CM/CMQ - CM/CR

CM

CM/CMQ - CM/CR

CM/CMQ - CM/CR

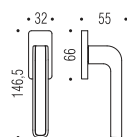
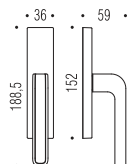
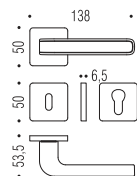



Materiale: Cromall®
Material: Cromall®





TENDER

ARCHITETTURA LABORATORIO

TENDER

MG 11 Design:
Architettura Laboratorio



OL
Oroplus



CM
Cromat
Matt chrome



NI
Nikelmat
Matt nickel

MG 11 R-RY Ø50

CD 49 BZG G Ø50

MG 12 IM

MG 12 DK/SM



OL - CM - NI

OL - CM - NI

OL - CM - NI

OL - CM - NI

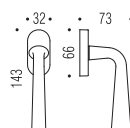
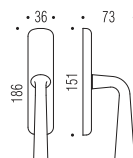
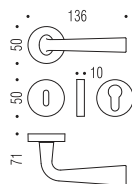



Materiale: Ottone
Material: Brass





TOOL

MICHELE DE LUCCHI

TOOL

MD 11 Design:
Michele De Lucchi



CR
Cromo
Chrome



CM
Cromat
Matt chrome

MD 11 R-RY Ø50

CD 49 BZG G Ø50

MD 12 IM

MD 12 DK/SM



CR - CM

CR - CM

CR - CM

CR - CM

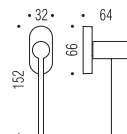
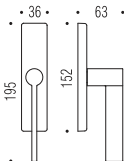
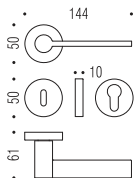



Materiale: Ottone
Material: Brass



TOOL

MD 11 Design:
Michele De Lucchi



CR
Cromo
Chrome



CM
Cromat
Matt chrome

MD 11 RF-RYF Ø50

FF 19 BZG Ø50

MD 12 DKF/SM



CR - CM

CR - CM

CR - CM

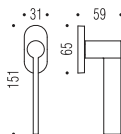
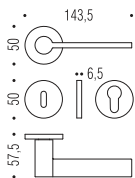



Materiale: Ottone
Material: Brass



I dettagli
non sono
dettagli.
Fanno
il design.

The details
are not
details.
They make
the design.

Charles Eames

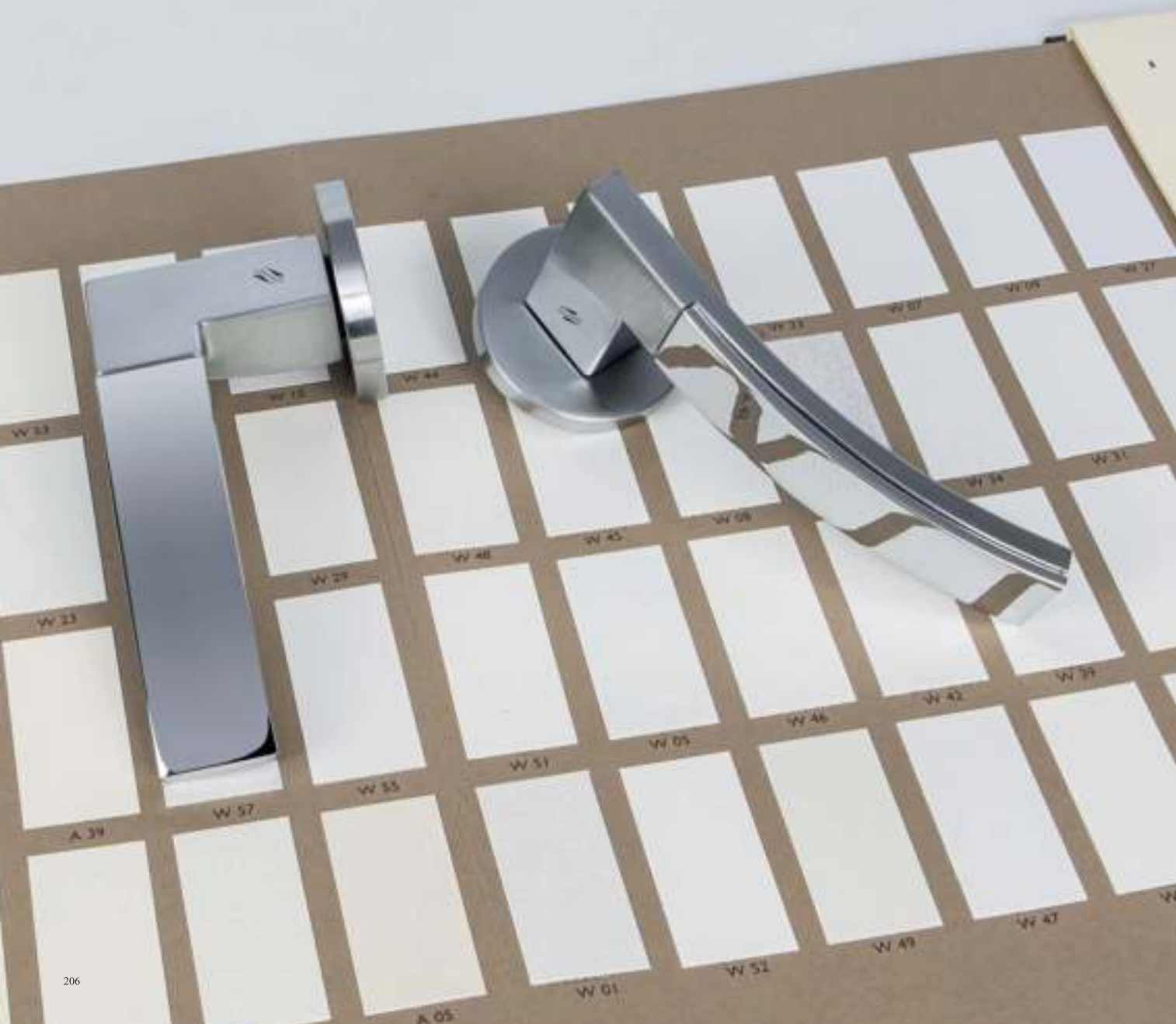

TRAMA

LUCA COLOMBO

TRAMA

LC 71 Design:
Luca Colombo



CM/CR
Cromat/Cromo
Matt chrome/Chrome

LC 71 R-RY Ø50



CM/CR

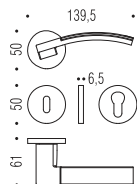

FF 19 BZG Ø50



CM



LC 72 IM



CM/CR

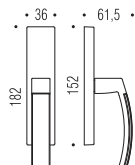

LC 72 DK/SM



CM/CR

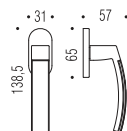



Materiale: Cromall®
Material: Cromall®

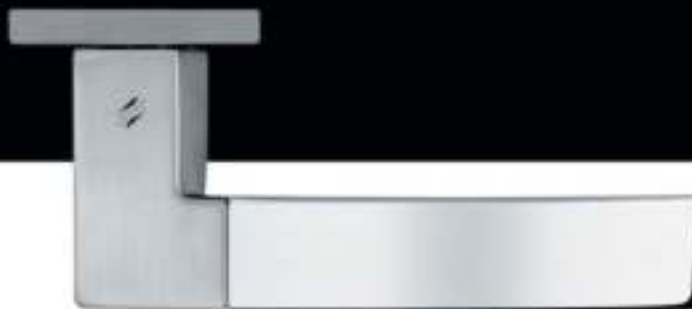



TRAMMA

LUCA COLOMBO

TRAMA

LC 81 Design:
Luca Colombo



CM/CR
Cromat/Cromo
Matt chrome/Chrome

LC 81 R-RY Ø50



CM/CR

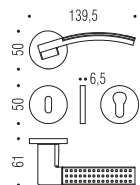

FF 19 BZG Ø50



CM



LC 82 IM



CM/CR

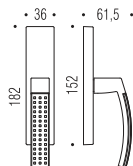

LC 82 DK/SM



CM/CR

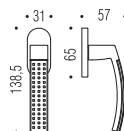



Materiale: Cromall®
Material: Cromall®





TWITTY

TOMO KIMURA

TWITTY

TK 11 Design:
Tomo Kimura



OL
Oroplus



CM
Cromat
Matt chrome



CR
Cromo
Chrome

TK 11 R-RY Ø50

CD 49 BZG G Ø50



OL - CR - CM

OL - CR - CM

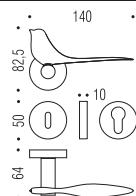



Materiale: Ottone
Material: Brass





VIOLA

ANGELETTI RUZZA DESIGN

VIOLA

AR 21 Design: Angeletti Ruzza Design



OL
Oroplus



CM
Cromat
Matt chrome



HPS/1
Zirconium
Stainless-steel



VL
Vintage



CR
Cromo
Chrome



VM
Vintage Mat

DKZERO

AR 21 R-RY Ø50

CD 49 BZG G Ø50

AR 22 IM

AR 22 DK/SM

AR 22 DK0/SM



OL-HPS/1-CR-CM-VL-VM

OL-HPS/1-CR-CM-VL-VM

OL-HPS/1-CR-CM-VL-VM

OL-HPS/1-CR-CM-VL-VM

CR - CM

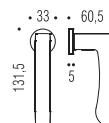
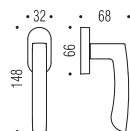
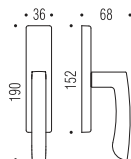
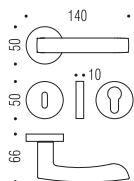



Materiale: Ottone
Material: Brass





WING

DI BLASI ASSOCIATI

WING

DB 31 Design:
Di Blasi Associati



OL
Oroplus



CM
Cromat
Matt chrome

DB 31 R-RY Ø50

CD 49 BZG G Ø50

DB 32 IM

DB 32 DK/SM



OL - CM

OL - CM

OL - CM

OL - CM

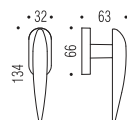
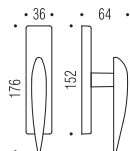
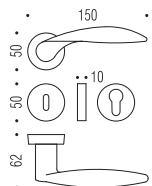



Materiale: Ottone
Material: Brass



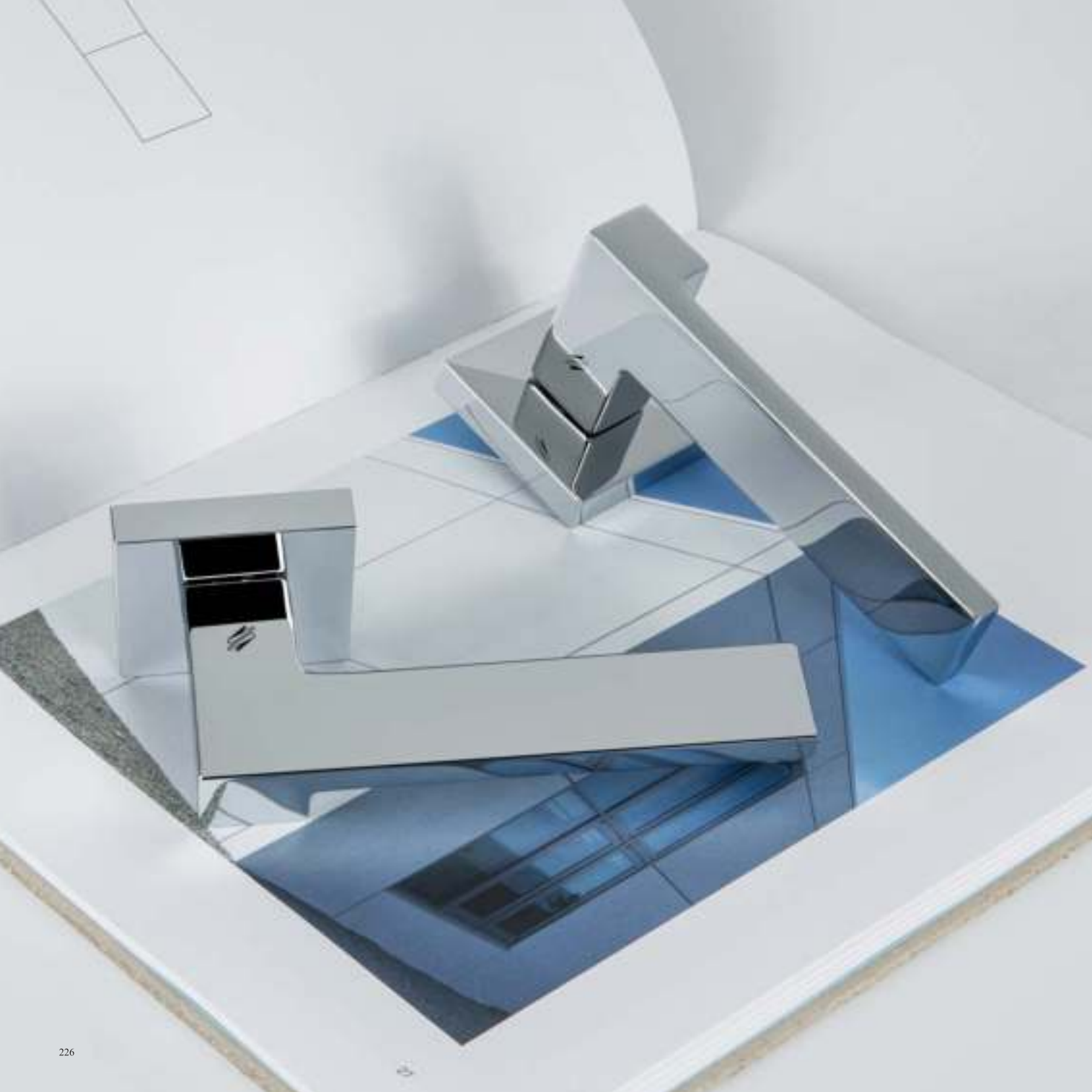

ZELDA

JEAN MARIE MASSAUD

ZELDA

MM 11 Design:
Jean Marie Massaud



CR
Cromo
Chrome



CM
Cromat
Matt chrome

DKZERO

MM 11 R-RY 52x52

MM 29 BZG 52x52

MM 12 IM

MM 12 DK/SM

MM 12 DK0/SM



CR - CM

CR - CM

CR - CM

CR - CM

CR - CM

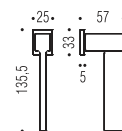
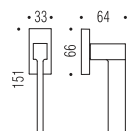
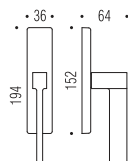
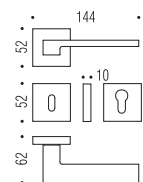



Materiale: Ottone
Material: Brass



ZELDA

MM 11 Design:
Jean Marie Massaud



CR
Cromo
Chrome



CM
Cromat
Matt chrome

DKZERO

MM 11 **RF-RYF** 50x50

FF 29 **BZG** 50x50

MM 12 **DKF/SM**

MM 12 **DK0/SM**



CR - CM

CR - CM

CR - CM

CR - CM

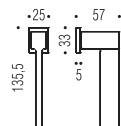
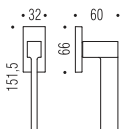
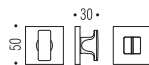
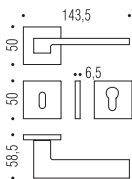



Materiale: Ottone
Material: Brass



2021 EDITION

Classic Line

MADE IN ITALY



per un'occasione avesse da realizzarsi
di un piano stabile, mentre la società
sugli organi di lavoro, ed anche dopo
ogni il grande affido il vecchio busto
di un'azione importante.

Tale la costante mancanza di sostegni di
ipotesi di condanna, via il Comune
Adattamenti nel proprio del Stato
di altre istituzioni (contenuti nel libro
a non volta agli interessi individuali)
1873, il Senato discute da una
sessori di forti alla ribalta, al potenziamento
di 15 al sabato, e il 30 aprile, integrato e
provvisoriamente del 1868 e del 1868, è
tutto per la Giunta municipale definitiva
di affidare al proprietario che accetta, i lavori
sistemati, stabiliti dalla commissione di lavoro
regime nazionali il 31 maggio 1877 dal Co
monale, che stanno inoltre oltre 11.250 lire
riduzione dei costi architettonici, nonché
su dei lavori di restauro indispensabili, fatte de
appare occasionali (ingegneri Prosperi che ha cre
si il proprio del Monti. L'assemblea dei comi
per tutto suo, approssa la spesa di Lire 30.000,
lancio la commissione per i restauri approssa l'a
alla revisione al Comune di due polizi,
con del fero nella volta della platea prevedendone
si sparsi per alzare e abbassare la "luminosa" a pe
per far uscire il calore e il fumo prodotti dalle lamp
de. Nell'estensione del lavoro, viene fatta riferire
agli enti Comunali (proprietari del palazzo vesco
al tutto, di poter incassare lo spazio, di progettare
comitato, che esiste lungo la facciata San Paolo fra il
palazzo e il teatro, e di vedere o affidare due vani del
palazzo da affittare a caffè. Ma è necessario a questi
potrà migliorare il contrasto con la famiglia Conventati
per l'abitazione chiusura di una finestra Conventati
denuncia il rifacimento della volta, già oggetto di con
istituzioni dopo i lavori del 1858.
I lavori di restauro

CAMEO

OTTAVIO DI BLASI

CAMEO

DB 41 Design:
Ottavio Di Blasi



OL
Oroplus



BR
Bronzo
Bronze



CR
Cromo
Chrome

DB 41 P-PY



OL - CR - BR

DB 41 R-RY 63x50



OL - CR - BR

DB 19 BZG 63x50



OL - CR - BR

DB 42 IM



OL - CR - BR

DB 42 DK/SM



OL - CR - BR

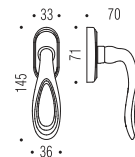
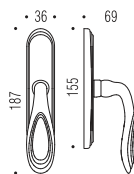
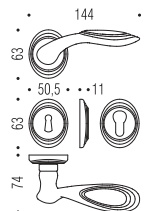
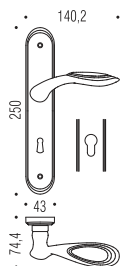



Materiale: Ottone
Material: Brass



*La ricerca
Sassini e*

...verranno le differenti versioni
...che assai chiaro che, per questo
...in progetto ben preciso da quel
...di fondazione di Romboldi a quel
...al quadro (la residenza si trova
...in dipinto) l'incendio, che sfuggì
...a Romboldi a priori, ma dov'era
...arrivò. Le differenti versioni
...sopra di questa ricerca.
...il libro biblico specificò di uno stesso
...suo stesso che, durante la
...sua vita, con il plurale
...attorno alla bella moglie che
...prima di nascosto da del
...samente e s'incendiò a noi.
...non era con te e perciò hai
...non puoi scappare da ogni parte.
...nelle nostre mani che peccare
...vane opposizione dalle vostre
...no che vecchi vengono
...in opposizione accusata e
...in opposizione. Il giovane è
...La prima versione è
...no di quadri a soggetto
...no nostro. Di quest'opera
...ambiguità del



HEIDI

COLOMBO DESIGN

HEIDI

CD 31 Design:
Colombo Design



OL
Oroplus



BR
Bronzo
Bronze

CD 31 P-PY



OL - BR

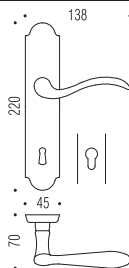

CD 31 R-RY Ø50



OL - BR

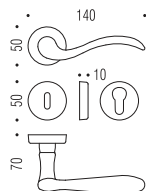

CD 69 BZG G Ø50



OL - BR



CD 32 M



OL - BR

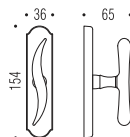

CD 32 DK/SM DX-SX



OL - BR

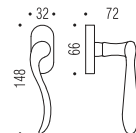



Materiale: Ottone
Material: Brass





LE ORIGINI TEATRALI

L

Il teatro è un'arte che ha una storia molto antica. Si ritiene che sia nato in Grecia, dove si svolgevano i drammi sacrali in onore degli dei. In seguito, si è diffuso in tutto il mondo, assumendo diverse forme e caratteristiche. Il teatro moderno si è sviluppato nel Rinascimento, quando si è cominciato a rappresentare storie e situazioni della vita quotidiana. Oggi, il teatro è una forma d'arte molto importante, che permette di esprimere emozioni e idee in modo molto potente. È un'arte che si evolve continuamente, adattandosi ai gusti e alle esigenze del pubblico. Il teatro è un'arte che ha una grande forza espressiva e che ha il potere di commuovere e ispirare. È un'arte che ha una grande importanza sociale e culturale. È un'arte che ha una grande bellezza e che ha il potere di elevare lo spirito umano. Il teatro è un'arte che ha una grande storia e che ha un grande futuro. È un'arte che ha una grande importanza e che ha il potere di cambiare il mondo.

IDA

COLOMBO DESIGN



OL
Oroplus



CR
Cromo
Chrome



BR
Bronzo
Bronze



OA
Ottone antico
Antique brass



BA
Bronzo antico
Antique bronze

ID 31 P-PY

ID 31 R-RY Ø50

CD 69 BZG G Ø50

ID 32 M

ID 32 DK/SM



OL - BR - OA - BA

OL - CR - BR - OA - BA

OL - CR - BR - OA - BA

OL - CR - BR - OA - BA

OL - CR - BR - OA - BA

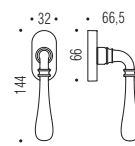
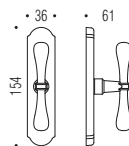
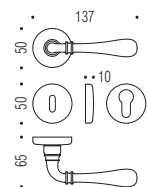
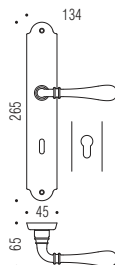



Materiale: Ottone
Material: Brass

PRIMA GARANTIA 10 ANNI
10
CORRISPONDING 10 YEARS WARRANTY





PETER

COLOMBO DESIGN

PETER

ID 11 Design:
Colombo Design



OL
Oroplus



BR
Bronzo
Bronze



OM
Oromat
Matt gold



OA
Ottone antico
Antique brass

ID 11 P-PY

ID 11 R-RY Ø50

CD 69 BZG G Ø50

CD 32 M

ID 12 DK/SM DX-SX



OL - OM - BR - OA



OL - OM - BR - OA



OL - OM - BR - OA



OL - OM - BR - OA



OL - OM - BR - OA

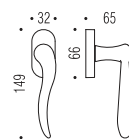
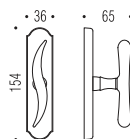
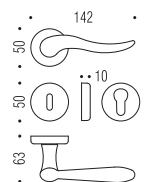
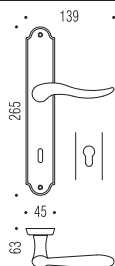



Materiale: Ottone
Material: Brass





PIUMA

ANGELETTI RUZZA DESIGN

PIUMA

AR 11 Design: Angeletti Ruzza Design



OL
Oroplus



BR
Bronzo
Bronze

AR 11 P-PY



OL - BR

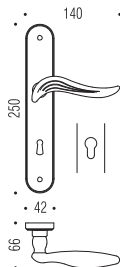

AR 11 R-RY Ø50



OL - BR

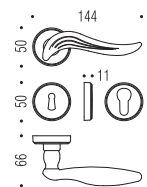

CD 79 BZG Ø50



OL - BR



AR 12 M



OL - BR

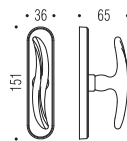

AR 12 DK/SM



OL - BR

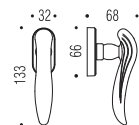



Materiale: Ottone
Material: Brass



La funzione
del design è di
permettere
al design
di funzionare.

The function
of design is
letting design
function.

Micha Commeren

2021 EDITION

ROBOTECH®

MADE IN ITALY



MACH

COLOMBO DESIGN

MACH

CD 81 Design:
Colombo Design



HPS
Zirconium Gold



CM
Cromat
Matt chrome



OL
Oroplus



NI
Nikelmat
Matt nickel



OM
Oromat
Matt gold



OA
Ottone antico
Antique brass

CD 81 P-PY

CD 81 R-RY Ø50

CD 69 BZG G Ø50

CD 82 IM

CD 82 DK/SM



HPS - OL - CM - OA

HPS-OL-OM-CM-NI-OA

HPS-OL-OM-CM-NI-OA

HPS-OL-OM-CM-NI-OA

HPS-OL-OM-CM-NI-OA

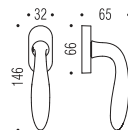
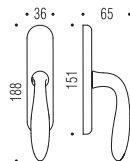
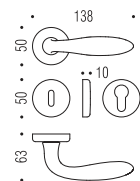
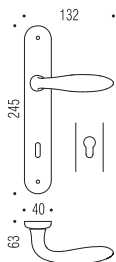



Materiale: Cromall®/Ottone
Material: Cromall®/Brass





www.digitalre.it

L

tecnologia / business /

INTELLIGENZA LABORATORI

11/2018_n. 78

Cartoncino CKB Nude™
by Stora Enso 230 g/m²

Stampa quadricromia

Nobilizzazione di...

Foil...

ROBOT

COLOMBO DESIGN

ROBOT

CD 41 Design:
Colombo Design



OL
Oroplus



NM RAL 9005
Neromat
Matt Black



CR
Cromo
Chrome



BI RAL 9016
Biancomat
Matt White



CM
Cromat
Matt chrome

DKZERO



CD 41 P-PY

CD 41 R-RY Ø50

CD 69 BZG G Ø50

CD 42 M

CD 42 IM

CD 42 DK/SM

CD 42 DK0/SM

CD 42 DK Z



OL - CR - CM

OL - CR - CM - NM - BI

OL - CR - CM - NM - BI

OL - CR - CM - NM - BI

OL - CM

OL - CR - CM - NM - BI

OL - CR - CM - NM - BI

OL - CR - CM

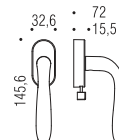
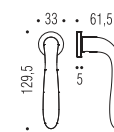
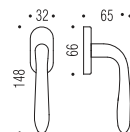
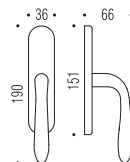
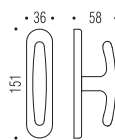
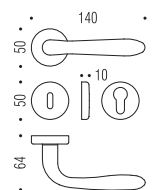
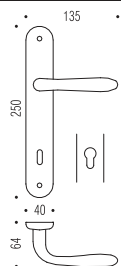



Materiale: Cromall®
Material: Cromall®





ROBOT

COLOMBO DESIGN

ROBOT

CD **75** Design:
Colombo Design



HPS
Zirconium Gold



CM
Cromat
Matt chrome



OM
Oromat
Matt gold



BR
Bronzo
Bronze



CR
Cromo
Chrome

CD 75 R-RY Ø50

CD 69 BZG G Ø50



HPS - OM - CR - CM - BR

HPS - OM - CR - CM - BR

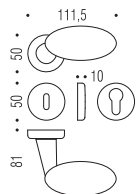

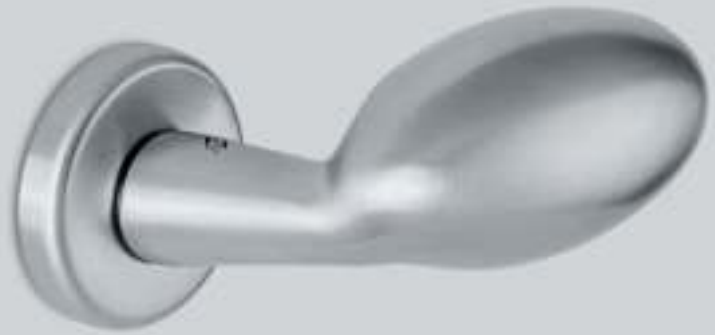

Materiale: Ottone
Material: Brass





ROBODUE

COLOMBO DESIGN

ROBODUE

CD 51 Design:
Colombo Design



OL
Oroplus



CR
Cromo
Chrome



CM
Cromat
Matt chrome

CD 51 P-PY

CD 51 R-RY Ø50

CD 69 BZG G Ø50

CD 52 M

CD 52 DK/SM



OL - CR - CM

OL - CR - CM

OL - CR - CM

OL - CR - CM

OL - CR - CM

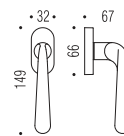
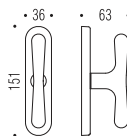
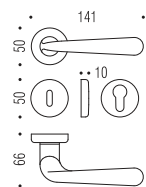
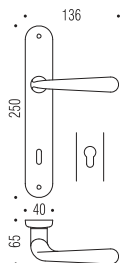



Materiale: Cromall®
Material: Cromall®



COMMUNICATION

End il bus... ...ion

Le tecnologie digitali di collaborazione innovative sono in grado di definire nuovi modelli di lavoro, con una cura della relazione

Unified Communications
smart working

L'impegno...
collaborativo...
nuovi modelli...
basati su...
nuovi da...
multimedia e...
multimediali

I trend di mercato

Michela Dall'Acqua
Collaborazione e
Digitalizzazione di lavoro
Italia, ci aiuta a fotografare
il mercato e a tracciare una
prospettiva di futuro.
Chiamata a fotografare
comunicazione, la ricerca in
possibile identificare i
multimediali che in questo
mercato riguardano diversi
contesto, con una serie
possibilità di
colloquio con
colloquio con
in Cloud e mobile. Le
di deployment di
di deployment di
e la semplicità
del servizio, la facilità di
diffusione, sono molti
in particolare, sono molti
sono ancora modelli ibridi,
con adozione...
o vi sono...



ROBOTRE

COLOMBO DESIGN

ROBOTRE

CD 91 Design:
Colombo Design



HPS
Zirconium Gold



CR
Cromo
Chrome



OL
Oroplus



CM
Cromat
Matt chrome



OM
Oromat
Matt gold



BR
Bronzo
Bronze



DKZERO

CD 91 P-PY	CD 91 R-RY Ø50	CD 69 BZG G Ø50	CD 92 IM	CD 92 DK/SM	CD 92 DK0/SM	CD 92 DK Z
OL - CM	HPS-OL-OM-CR-CM-BR	HPS-OL-OM-CR-CM-BR	HPS-OL-OM-CR-CM-BR	HPS-OL-OM-CR-CM-BR	OL - OM - CR - CM	OL - CR - CM



Materiale: Cromall®/Ottone
Material: Cromall®/Brass



C, ELO UTO ATA

QUALE STRATEGIA DEVONO METTERE IN ATTO LE IMPRESE PER PROTEGGERSI AL MEGLIO?

L'evoluzione digitale richiede un nuovo approccio alla sicurezza. Serve un cambio di passo, che deve essere riproposto via dal management che dai dipendenti. Per riuscire a contrastare gli attori continui dei crimini informatici, le organizzazioni devono includere le strategie di sicurezza nei loro sforzi di digital transformation. Dovranno inserirla nei piani di sviluppo e di crescita e comprendere che non si tratta di un costo, ma di un investimento.

che nel cloud. Questo approccio di considerare una threat intelligence utilizzabile in modo rapido riduce le finestre di rilevamento e fornisce una risoluzione necessaria per gli exploit di oggi. Consente quindi di trovare le soluzioni per reagire all'ansiosa alla minaccia. Velocità, integrazione e automazione sono i fattori fondamentali per la per questo Fortinet rivolge alle imprese dimensioni, dalle infatti devono essere difesa, le differenziali di investimento.

correlata e condivisa tra tutti gli elementi di sicurezza deve essere automatizzata per ridurre le finestre di rilevamento necessarie e fornire una soluzione rapida. L'integrazione dei singoli prodotti attraverso la rete distribuita, combinata alla segmentazione strategica, contribuirà in modo significativo a combattere la natura sempre più intelligente e automatizzata degli attacchi. I dispositivi di sicurezza di legacy e isolati e una scarsa considerazione della sicurezza continuano a rappresentare un pericolo e aumentano il rischio nel panorama delle minacce odierne, poiché non forniscono visibilità o controllo adeguati. Invece, un "security fabric", un tessuto di sicurezza che copra tutto l'ambiente di rete esteso e integrato tra ogni elemento, è vitale per gestire il panorama odierno in continua crescita e per ridurre il rischio di attacco in

IN QUESTO
SEMPRE
(SOFT
NETW
RETI
INTE
IN S
L
ST
r

Fortinet continuano a colpire le minacce. Lo confermano le analisi condotte dal team FortiGuard Labs del Global Threat Landscape

Le organizzazioni continuano a incorporare nuove minacce e a sfruttare tecniche sempre più automatizzate in termini di velocità e scalabilità per le loro attività dannose, segmentazione e integrazione diventano elementi critici di sicurezza strategica per gli ambienti IT e OT odierni. Non esiste una strategia di difesa futura che includa l'automazione o il machine learning senza un mezzo per raccogliere, elaborare e agire sulle informazioni sulle minacce in modo integrato per produrre una risposta intelligente.

COS'È IL SECURITY FABRIC?
E l'approccio di Fortinet al tema di cyber security, è l'insieme di soluzioni per rispondere alle minacce con una piattaforma organicamente da zero, che offre un ampio set di funzionalità di sicurezza con automazione eccezionali, e l'implementazione in modo

ROBOQUATTRO

COLOMBO DESIGN

ROBOQUATTRO

ID 41 Design:
Colombo Design



OL
Oroplus



CM
Cromat
Matt chrome



OM
Oromat
Matt gold



BI RAL 9016
Biancomat
Matt White



CR
Cromo
Chrome



DKZERO

ID 41 R-RY Ø50

CD 49 BZG G Ø50

ID 42 IM

ID 42 DK/SM

ID 42 DK0/SM

ID 42 DK Z



OL - OM - CR - CM - BI

OL - OM - CR - CM - BI

OL - OM - CR - CM - BI

OL - OM - CR - CM - BI

OL - OM - CR - CM

OL - CR - CM - BI

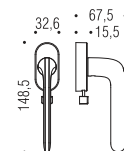
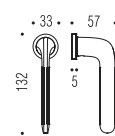
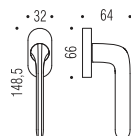
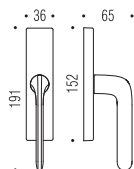
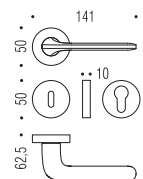



Materiale: Cromall®
Material: Cromall®



ROBOQUATTROS

COLOMBO DESIGN

ROBOQUATTROS

ID 51 Design:
Colombo Design



OL
Oroplus



VL
Vintage



CR
Cromo
Chrome



VM
Vintage Mat



CM
Cromat
Matt chrome



DKZERO

ID 51 R-RY 52x52

PT 19 BZG 52x52

ID 42 IM

ID 52 DK/SM

ID 52 DK0/SM

ID 52 DK Z

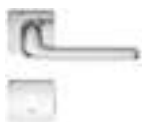

OL - CR - CM - VL - VM

OL - CR - CM - VL - VM

OL - CR - CM - VL - VM

OL - CR - CM - VL - VM

CR - CM - VM

CR - CM

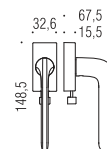
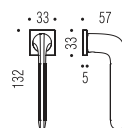
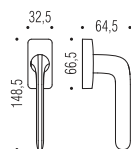
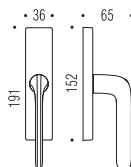
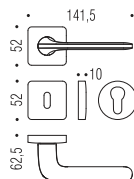



Materiale: Cromall®
Material: Cromall®





ROBOCINQUE

COLOMBO DESIGN

ROBOCINQUE

ID 61 Design:
Colombo Design



OL
Oroplus



NM RAL 9005
Neromat
Matt Black



CR
Cromo
Chrome



BI RAL 9016
Biancomat
Matt White



CM
Cromat
Matt chrome

DKZERO



ID 61 R-RY Ø50

CD 49 BZG G Ø50

ID 62 1M

ID 62 DK/SM

ID 62 DK0/SM

ID 62 DK Z



OL - CR - CM - NM - BI

OL - CR - CM - NM - BI

OL - CR - CM - NM - BI

OL - CR - CM - NM - BI

OL - CR - CM - NM - BI

CR - CM

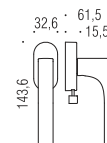
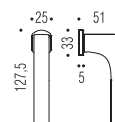
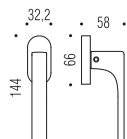
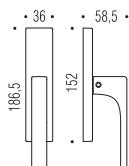
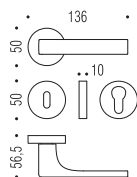



Materiale: Cromall®
Material: Cromall®



Supporterà 9 ne pieghevoli

È

difficile, lo ha annunciato Google. La sua
dispositivi pieghevoli con il suo sistema
in modo nativo il supporto a questi
Gli ingegneri sono già all'opera
Engineering di Android, ha speso
permettere agli sviluppatori, in fo-
Il sistema operativo del robotino ve-
lino dispositivi che girano con And-
dispositivo che può essere pensato sia come
definito dallo stesso vice presidente
"In generale", spiega Burke, "ci sono due
singolo schermo. Una volta piegato, il
in scena. La caratteristica che definirei questo fattore di
chiamiamo "compatibilità".
Con questa spiegazione, Burke non solo accenna alla cara
sità decisa Android, che dalla "versione smartphone" pa-
Per il momento, infatti, l'unico grande produttore che
sarà dotato Samsung, quello del dispositivo
la realizzazione con un unico dispi-
pieghevole è stato Samsung, quello del dispositivo
altro tradizionale.
Per il momento, infatti, l'unico grande produttore che
sarà dotato Samsung, quello del dispositivo
la realizzazione con un unico dispi-
pieghevole è stato Samsung, quello del dispositivo
altro tradizionale.

di pregato, isolando su una parte della
di realizzazione con un unico dispi-
pieghevole è stato Samsung, quello del dispositivo
altro tradizionale.
Per il momento, infatti, l'unico grande produttore che
sarà dotato Samsung, quello del dispositivo
la realizzazione con un unico dispi-
pieghevole è stato Samsung, quello del dispositivo
altro tradizionale.

Il mercato del prossimo anno e che presenta due
chiamiamo "compatibilità".
Con questa spiegazione, Burke non solo accenna alla cara
sità decisa Android, che dalla "versione smartphone" pa-
Per il momento, infatti, l'unico grande produttore che
sarà dotato Samsung, quello del dispositivo
la realizzazione con un unico dispi-
pieghevole è stato Samsung, quello del dispositivo
altro tradizionale.

ROBOCINQUES

COLOMBO DESIGN

ROBOCINQUE S

ID 71 Design:
Colombo Design



CR
Cromo
Chrome



GL
Grafite
Graphite



CM
Cromat
Matt chrome



GM
Grafite Mat
Matt graphite



BI RAL 9016
Biancomat
Matt White



NM RAL 9005
Neromat
Matt Black

DKZERO



ID 71 R-RY 52x52

MM 29 BZG 52x52

ID 62 IM

ID 72 DK/SM

ID 72 DK0/SM

ID 72 DK Z



CR - CM - GL - GM - NM - BI

CR - CM - GL - GM - NM - BI

CR - CM - NM - BI

CR - CM - GL - GM - NM - BI

CR - CM - GM - NM - BI

CR - CM

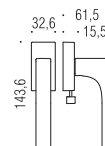
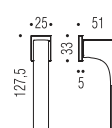
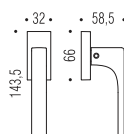
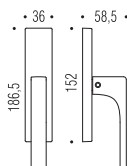
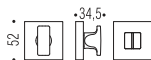
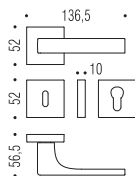



Materiale: Cromall®
Material: Cromall®



Il buon design
è ovvio.
Il grande
design è
trasparente.

Good design
is obvious.
Great design
is transparent.

Joe Sparano

2021 EDITION

Pomoli

Door Knobs

MADE IN ITALY

BOLD

PT 15 Design:
Pio e Tito Toso lab



CR
Cromo
Chrome



CM
Cromat
Matt chrome

PT 15



CR - CM





Materiale: Ottone
Material: Brass



CUT

MS 15 Design:
Messineo e Settimelli



CR
Cromo
Chrome



CM
Cromat
Matt chrome

MS 15



CR - CM





Materiale: Cromall®/Ottone
Material: Cromall®/Brass



CUT

MS 25 Design:
Messineo e Settimelli



CR
Cromo
Chrome



CM
Cromat
Matt chrome

MS 25



CR - CM

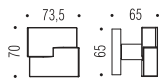



Materiale: Cromall®/Ottone
Material: Cromall®/Brass

• **10** ANNI
• GARANZIA
• 10 YEARS WARRANTY



DAYTONA

PF 15 Design: *pininfarina*



HPS
Zirconium Gold



CM
Cromat
Matt chrome

PF 15



HPS - CM





Materiale: Ottone
Material: Brass



DROP

LC 45 Design:
Luca Colombo



HPS
Zirconium Gold



CR
Cromo
Chrome



CM
Cromat
Matt chrome



BR
Bronzo
Bronze

LC 45



HPS - CR - CM - BR

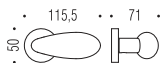

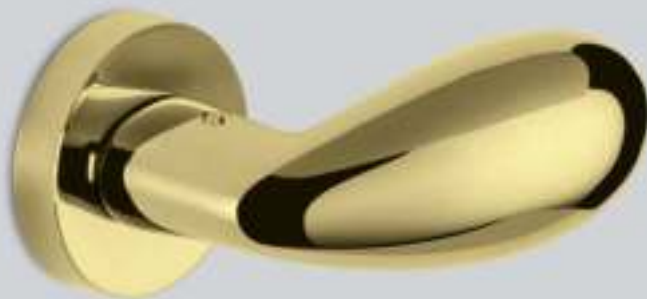

Materiale: Ottone
Material: Brass



ETRO

DB 15 Design:
Di Blasi Associati



OL/OM
Oroplus/Oromat
Oroplus/Matt gold



CR/CM
Cromo/Cromat
Chrome/Matt chrome

DB 15



OL/OM - CR/CM

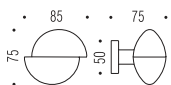



Materiale: Ottone
Material: Brass



MAPO

RM 15 Design:
Mauro Ronchi



CR
Cromo
Chrome



CM
Cromat
Matt chrome



NM RAL 9005
Neromat
Matt Black

RM 15



CR - CM - NM



Materiale: Ottone
Material: Brass



MOON

BD **15** Design:
Bartoli Design



HPS
Zirconium Gold



CR
Cromo
Chrome



CM
Cromat
Matt chrome

BD 15



HPS - CR - CM

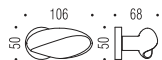



Materiale: Ottone
Material: Brass

• FINITURA GARANTITA 10 ANNI •
10
• FINISHING 10 YEARS WARRANTY •

• FINITURA GARANTITA 30 ANNI •
30
• FINISHING 30 YEARS WARRANTY •



PUSH

LC 55 Design:
Luca Colombo



HPS
Zirconium Gold



CR
Cromo
Chrome



CM
Cromat
Matt chrome



GM
Grafite Mat
Matt graphite

LC 55



HPS - CR - CM - GM

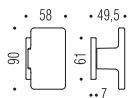



Materiale: Ottone
Material: Brass



ROBOT

CD 45 Design:
Colombo Design



HPS
Zirconium Gold



OL
Oroplus



OM
Oromat
Matt gold



CR
Cromo
Chrome



CM
Cromat
Matt chrome



NI
Nikelmat
Matt nickel



BR
Bronzo
Bronze



BA
Bronzo antico
Antique bronze



NM RAL 9005
Neromat
Matt Black

CD 45



HPS - OL - OM - CR - CM

NI - BR - BA - NM





Materiale: Ottone
Material: Brass

FINITURA GARANTITA 10 ANNI
FINISHING 10 YEARS WARRANTY

FINITURA GARANTITA 30 ANNI
FINISHING 30 YEARS WARRANTY

ROBOTECH®
CLOMBO DESIGN



ROBOT

CD 55 Design:
Colombo Design



HPS
Zirconium Gold



HPS/1
Zirconium
Stainless-steel



BR
Bronzo
Bronze



OL
Oroplus



CR
Cromo
Chrome



OA
Ottone antico
Antique brass



OM
Oromat
Matt gold



CM
Cromat
Matt chrome

CD 55



HPS - OL - OM - HPS/1

CR - CM - BR - OA





Materiale: Ottone
Material: Brass



ROBOT

CD 65 Design:
Colombo Design



HPS
Zirconium Gold



OL
Oroplus



CM
Cromat
Matt chrome

CD 65



HPS - OL - CM





Materiale: Ottone
Material: Brass



ROBOT

CD 75 Design:
Colombo Design



HPS
Zirconium Gold



CM
Cromat
Matt chrome



OM
Oromat
Matt gold



BR
Bronzo
Bronze



CR
Cromo
Chrome

CD 75



HPS - OM - CR - CM - BR

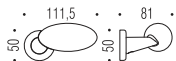

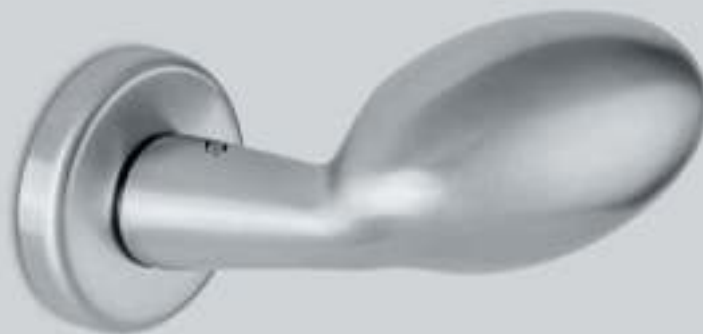

Materiale: Ottone
Material: Brass



ROUND

ID 25 Design:
Colombo Design



OL
Oroplus



GM
Grafite Mat
Matt graphite



CR
Cromo
Chrome



CM
Cromat
Matt chrome

ID 25



OL - CR - CM - GM





Materiale: Ottone
Material: Brass



ROUND

ID 35 Design:
Colombo Design



HPS
Zirconium Gold



CM
Cromat
Matt chrome



OL
Oroplus



GM
Grafite Mat
Matt graphite



CR
Cromo
Chrome

ID 35



HPS - OL - CR - CM - GM





Materiale: Ottone
Material: Brass



SPIDER

MR **15** Design:
Matteo Ragni



CR
Cromo
Chrome



CM
Cromat
Matt chrome

MR 15



CR - CM

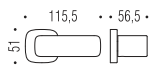



Materiale: Ottone
Material: Brass



SQUARE

LC 15 Design:
Luca Colombo



CR
Cromo
Chrome



CM
Cromat
Matt chrome

LC 15



CR - CM

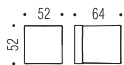



Materiale: Ottone
Material: Brass



SQUARE

LC 25 Design:
Luca Colombo



CR
Cromo
Chrome



VM
Vintage mat



CM
Cromat
Matt chrome



GM
Grafite Mat
Matt graphite



VL
Vintage

LC 25



CR - CM - VL - VM - GM

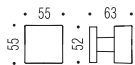



Materiale: Ottone
Material: Brass



SQUARE

LC 35 Design:
Luca Colombo



CR
Cromo
Chrome



CM
Cromat
Matt chrome



GM
Grafite Mat
Matt graphite

LC 35



CR - CM - GM





Materiale: Ottone
Material: Brass



2021 EDITION

Maniglioni e Battenti

Pulls and door Knockers

MADE IN ITALY

DAYTONA

PF 16 Design: *pininfarina*



HPS
Zirconium Gold



CM
Cromat
Matt chrome

PF 16



HPS - CM

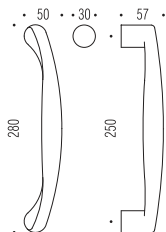

Maniglioni senza rosette
Pulls without roses

Materiale: Ottone
Material: Brass



ELLE

ID 36 Design:
TEAM 3



HPS/1
Zirconium
stainless-steel



NM RAL 9005
Neromat
Matt Black



CR
Cromo
Chrome



BI RAL 9016
Biancomat
Matt White



CM
Cromat
Matt chrome

ID 36



HPS/1 - CR - CM - BI - NM

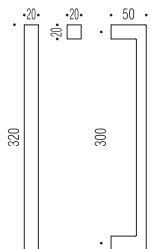

Maniglioni senza rosette
Pulls without roses

Materiale: Cromall®
Material: Cromall®



FIVE

ID 56 Design:
Colombo Design



OL
Oroplus



GL
Grafite
Graphite



BI RAL 9016
Biancomat
Matt White



CR
Cromo
Chrome



GM
Grafite Mat
Matt graphite



CM
Cromat
Matt chrome



NM RAL 9005
Neromat
Matt Black

ID 56



OL - CR - CM - GL - GM - NM - BM

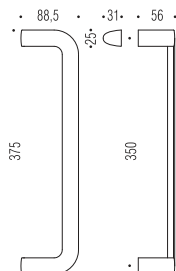

Maniglioni senza rosette
Pulls without roses

Materiale: Ottone
Material: Brass



FLESSO

CB 16 Design:
Carlo Bartoli



HPS
Zirconium Gold



CR
Cromo
Chrome



OL
Oroplus



CM
Cromat
Matt chrome



OM
Oromat
Matt gold



NM RAL 9005
Neromat
Matt Black

CB 16 Z/A

CB 16 Z/B



HPS - OL - OM - CR - CM - NM

HPS - OL - OM - CR - CM - NM

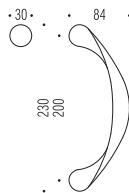
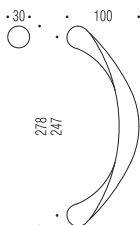

Maniglioni senza rosette
Pulls without roses

Materiale: Ottone
Material: Brass

• FINITURA GARANTITA 10 ANNI •
10
• FINISHING 10 YEARS WARRANTY •

• FINITURA GARANTITA 30 ANNI •
30
• FINISHING 30 YEARS WARRANTY •



LOGO

LC 16 Design:
Luca Colombo



HPS
Zirconium Gold



CR
Cromo
Chrome



OL
Oroplus



CM
Cromat
Matt chrome

LC 16

LC 16 L



HPS - CM

HPS - OL - CR - CM

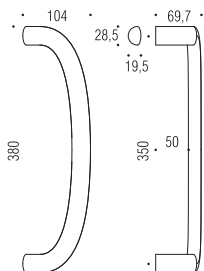
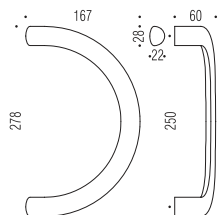

Maniglioni senza rosette
Pulls without roses

Materiale: Ottone
Material: Brass



LUND

SE 16 Design:
Claesson Koivisto Rune



CR
Cromo
Chrome



GL
Grafite
Graphite



CM
Cromat
Matt chrome



GM
Grafite Mat
Matt graphite

SE 16



CR - CM - GL - GM

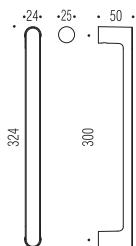

Maniglioni senza rosette
Pulls without roses

Materiale: Ottone
Material: Brass



NOA

ID 16 Design:
TEAM 3



HPS
Zirconium Gold



CR
Cromo
Chrome



HPS/1
Zirconium
stainless-steel



CM
Cromat
Matt chrome

ID 16 A

ID 16 B



HPS - HPS/1 - CR- CM

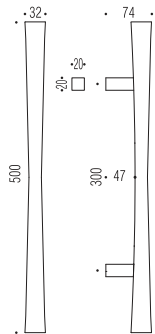

HPS - HPS/1 - CR- CM

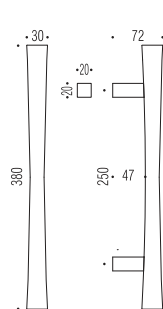

Maniglioni senza rosette
Pulls without roses

Materiale: Ottone
Material: Brass





HPS
Zirconium Gold



CR
Cromo
Chrome



HPS/1
Zirconium
stainless-steel



CM
Cromat
Matt chrome

ID 26 A

ID 26 B



HPS - HPS/1 - CR- CM

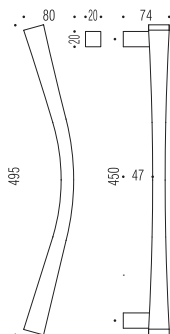

HPS - HPS/1 - CR- CM

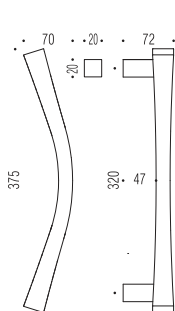

Maniglioni senza rosette
Pulls without roses

Materiale: Ottone
Material: Brass



ROBOQUATTRO

ID 46 Design:
Colombo Design



HPS
Zirconium Gold



CR
Cromo
Chrome



GL
Grafite
Graphite



OL
Oroplus



CM
Cromat
Matt chrome



GM
Grafite Mat
Matt graphite



OM
Oromat
Matt gold

ID 46 A

ID 46 B



HPS - OL - OM - CR - CM - GL - GM

HPS - OL - OM - CR - CM - GL - GM

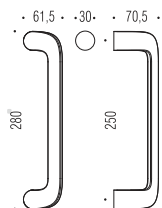
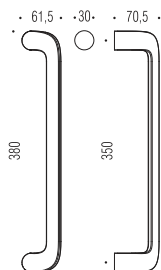

Maniglioni senza rosette
Pulls without roses

Materiale: Ottone
Material: Brass



SQUARE

MG 26 Design:
Architettura Laboratorio



HPS
Zirconium Gold



VL
Vintage



HPS/1
Zirconium
stainless-steel



VM
Vintage mat



CM
Cromat
Matt chrome

MG 26



HPS - HPS/1 - CM - VL - VM

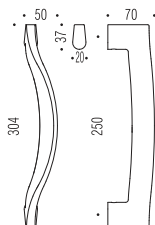

Maniglioni senza rosette
Pulls without roses

Materiale: Ottone
Material: Brass



TENDER

MG 16 Design:
Architettura Laboratorio



HPS
Zirconium Gold



CR
Cromo
Chrome



NI
Nikelmat
Matt nickel



OL
Oroplus



CM
Cromat
Matt chrome



BA
Bronzo antico
Antique bronze



OM
Oromat
Matt gold



NM RAL 9005
Neromat
Matt Black



OA
Ottone antico
Antique brass

MG 16

MG 16 L



HPS-OL-OM-CR-CM-NI-BA-OA-NM

HPS - OL - CR - CM

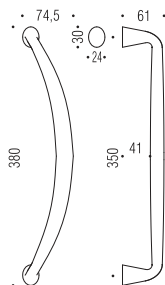
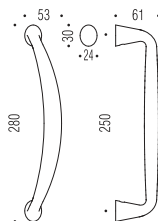

Maniglioni senza rosette
Pulls without roses

Materiale: Ottone
Material: Brass



WAVE

MP 16 Design:
Marco Piva



HPS/1
Zirconium
stainless-steel



CM
Cromat
Matt chrome

MP 16 A

MP 16 B



HPS/1 - CM

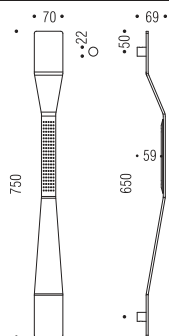

HPS/1 - CM

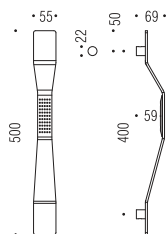

Maniglioni senza rosette
Pulls without roses

Materiale: Ottone
Material: Brass



ZEN

CB 36 Design:
Bartoli Design



HPS
Zirconium Gold



CR
Cromo
Chrome



HPS/1
Zirconium
stainless-steel



CM
Cromat
Matt chrome

CB 36 A

CB 36 B



HPS - HPS/1 - CR - CM

HPS - HPS/1 - CR - CM

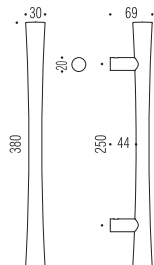
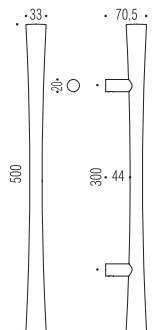

Maniglioni senza rosette
Pulls without roses

Materiale: Ottone
Material: Brass



ZEN

CB 46 Design:
Bartoli Design



HPS
Zirconium Gold



CR
Cromo
Chrome



HPS/1
Zirconium
stainless-steel



CM
Cromat
Matt chrome

CB 46 A

CB 46 B



HPS - HPS/1 - CR - CM

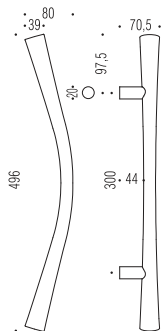

HPS - HPS/1 - CR - CM

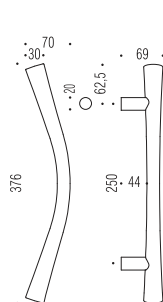

Maniglioni senza rosette
Pulls without roses

Materiale: Ottone
Material: Brass



BLUES

CD 36 Design:
Colombo Design



OL
Oroplus



CR
Cromo
Chrome



CM
Cromat
Matt chrome

CD 36



OL - CR - CM

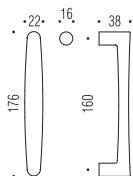

Maniglioni senza rosette
Pulls without roses

Materiale: Ottone
Material: Brass

• FINITURA GARANTITA 10 ANNI •
10
• FINISHING 10 YEARS WARRANTY •



JAZZ

CD 26 Design:
Bartoli Design



OL
Oroplus



CR
Cromo
Chrome



CM
Cromat
Matt chrome

CD 26



OL - CR - CM

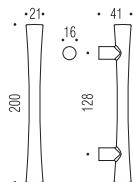

Maniglioni senza rosette
Pulls without roses

Materiale: Ottone
Material: Brass

• FINITURA GARANTITA 10 ANNI •
10
• FINISHING 10 YEARS WARRANTY •



NICE

CB 26 Design:
Carlo Bartoli



HPS
Zirconium Gold



OL
Oroplus



CM/CR
Cromat/Cromo
Matt chrome/Chrome

CB 26



HPS - OL - CM/CR

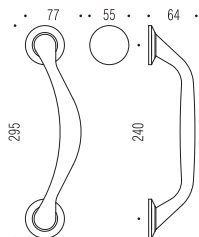

Maniglioni con rosette
Pulls with roses

Materiale: Ottone
Material: Brass

• FINITURA GARANTITA 10 ANNI •
10
• FINISHING 10 YEARS WARRANTY •

• FINITURA GARANTITA 30 ANNI •
30
• FINISHING 30 YEARS WARRANTY •



PIUMA

AR 16 Design:
Angeletti Ruzza Design



OL
Oroplus



BR
Bronzo
Bronze

AR 16



OL - BR

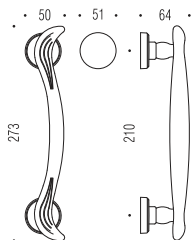

Maniglioni con rosette
Pulls with roses

Materiale: Ottone
Material: Brass

• FINITURA GARANTITA 10 ANNI •
10
• FINISHING 10 YEARS WARRANTY •



ROBOT

CD 16 Design:
Colombo Design



OL
Oroplus



CM
Cromat
Matt chrome

CD 16 A



CD 16 B



OL - CM

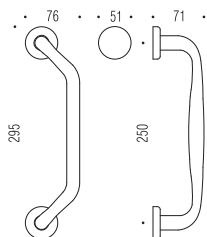

OL - CM

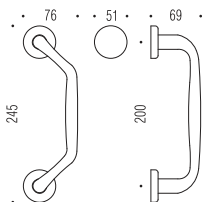

Maniglioni con rosette
Pulls with roses

Materiale: Ottone
Material: Brass



CLOUD

LC 26 Design:
Luca Colombo



HPS/1
Zirconium
stainless-steel



CR
Cromo
Chrome



CM
Cromat
Matt chrome

LC 26



HPS/1 - CR - CM

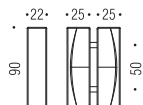

Maniglioni per ante in vetro
Pulls for glass door

Materiale: Ottone
Material: Brass



• FINITURA GARANTITA 10 ANNI •
10
• FINISHING 10 YEARS WARRANTY •

• FINITURA GARANTITA 30 ANNI •
30
• FINISHING 30 YEARS WARRANTY •

WIND

LC 36

LC 46

LC 56

Design:
Luca Colombo



CR
Cromo
Chrome



CM
Cromat
Matt chrome

LC 36

LC 46

LC 56



CR - CM

CR - CM

CR - CM

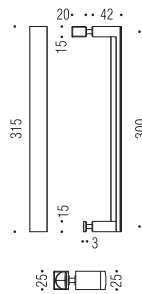
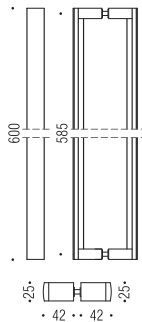
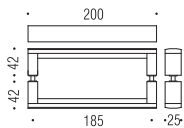

Maniglioni per ante in vetro
Pulls for glass door

Materiale: Ottone
Material: Brass



AM113-AM213Y

Design:
Alberto Meda



OL
Oroplus



CM
Cromat
Matt chrome

AM 113



OL - CM

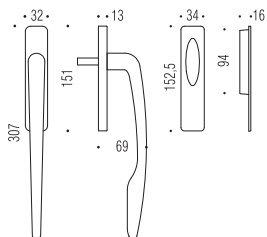

AM 213 Y



OL - CM

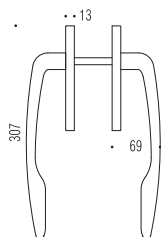

Maniglioni per alzante scorrevole
Pull-up handles for sliding door

Materiale: Ottone
Material: Brass



ID 113 - ID 213 Y

Design:
Colombo Design



HPS
Zirconium Gold



CR
Cromo
Chrome



BR
Bronzo
Bronze



OL
Oroplus



CM
Cromat
Matt chrome



OM
Oromat
Matt gold



NI
Nikelmat
Matt nickel

ID 113

ID 213 Y



HPS - OL - OM - CR - CM - NI - BR

OL - CM

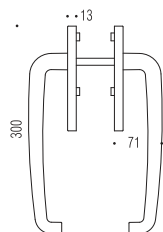
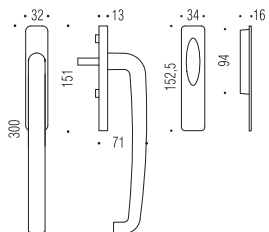

Maniglioni per alzante scorrevole
Pull-up handles for sliding door

Materiale: Ottone
Material: Brass



ID 313 - ID 413 Y

Design:
Colombo Design



OL
Oroplus



CM
Cromat
Matt chrome



OM
Oromat
Matt gold



VM
Vintage mat



CR
Cromo
Chrome

ID 313

ID 413 Y



OL - OM - CR - CM - VM

OL - CM

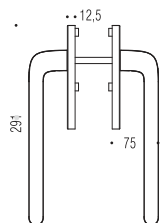
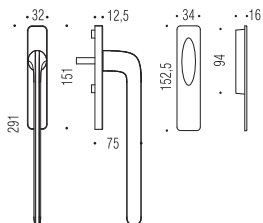

Maniglioni per alzante scorrevole
Pull-up handles for sliding door

Materiale: Ottone
Material: Brass



ID513-ID613Y

Design:
Colombo Design



OL
Oroplus



GL
Grafite
Graphite



BI RAL 9016
Biancomat
Matt White



CR
Cromo
Chrome



GM
Grafite Mat
Matt graphite



CM
Cromat
Matt chrome



NM RAL 9005
Neromat
Matt Black

ID 513

ID 613 Y



OL - CR - CM - GL - GM - NM - BI

OL - CR - CM - GL - GM - NM

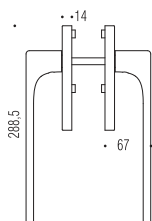
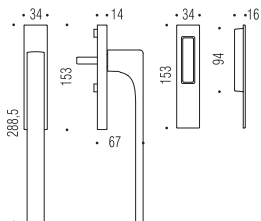

Maniglioni per alzante scorrevole
Pull-up handles for sliding door

Materiale: Ottone
Material: Brass



LC113-LC213Y

Design:
Luca Colombo



CR
Cromo
Chrome



CM
Cromat
Matt chrome

LC 113

LC 213 Y



CR - CM

CR - CM

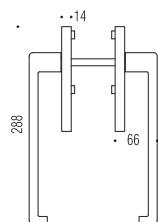
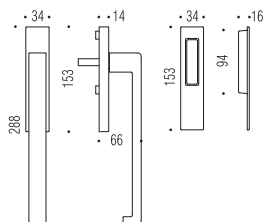

Maniglioni per alzante scorrevole
Pull-up handles for sliding door

Materiale: Ottone
Material: Brass



LC413-LC513Y

Design:
Luca Colombo



CR/CM
Cromo/Cromat
Chrome/Matt chrome



GL/GM
Grafite/Grafite Mat
Graphite/Matt graphite

LC 413



LC 513 Y



CR/CM - GL/GM

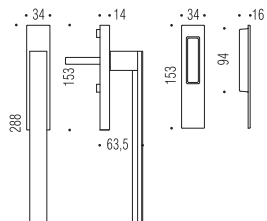

CR/CM - GL/GM

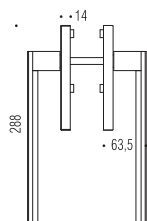

Maniglioni per alzante scorrevole
Pull-up handles for sliding door

Materiale: Ottone
Material: Brass



CD 113 MIGNON

Design:
Colombo Design



OL
Oroplus



CM
Cromat
Matt chrome

CD 113



OL - CM

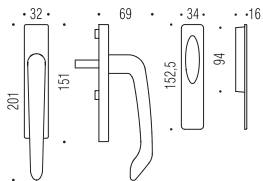

Maniglioni per alzante scorrevole
Pull-up handles for sliding door

Materiale: Ottone
Material: Brass



CD 213 RS

Design:
Colombo Design



OL
Oropius



CM
Cromat
Matt chrome

CD 213 RS



OL - CM

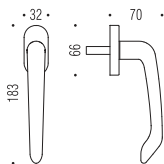

Maniglione per complanare
Pull for coplanar sliding door

Materiale: Ottone
Material: Brass



FLESSUM

CB 115 Design:
Bartoli Design



HPS
Zirconium Gold



CM
Cromat
Matt chrome

CB 115



HPS - CM

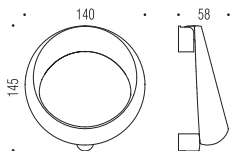

Battente
Door-knocker

Materiale: Ottone
Material: Brass



• FINITURA GARANTITA 10 ANNI •
10
• FINISHING 10 YEARS WARRANTY •

• FINITURA GARANTITA 30 ANNI •
30
• FINISHING 30 YEARS WARRANTY •

TOC-TOC

AM 115 Design:
Alberto Meda



HPS
Zirconium Gold



CM
Cromat
Matt chrome

AM 115



HPS - CM

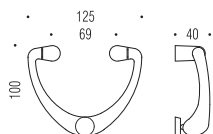

Battente
Door-knocker

Materiale: Ottone
Material: Brass



FINITURA GARANTITA 10 ANNI
10
FINISHING 10 YEARS WARRANTY

FINITURA GARANTITA 30 ANNI
30
FINISHING 30 YEARS WARRANTY

2021 EDITION

Maniglie ad incasso

Flush handles

MADE IN ITALY

ENTER

LC 211 Design:
Luca Colombo



OL
Oroplus



CR
Cromo
Chrome



CM
Cromat
Matt chrome

Kit per porta scorrevole composto da due maniglie ad incasso e maniglietta di trascinamento.

Sliding Doors Kit composed of two groove handles and flush handle.

Kit per porta scorrevole composto da due maniglie ad incasso con dispositivo di chiusura a nottolino, maniglietta di trascinamento e serratura (E 50mm).

Sliding Doors Kit composed of two groove handles with thumb turn from one side, flush handle and stainless-steel mortise hook lock (E 50mm) with striking plate.

LC 211



LC 211 LK

con serratura
with lock



OL - CR - CM

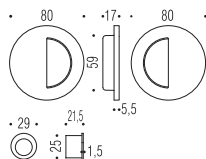

OL - CR - CM

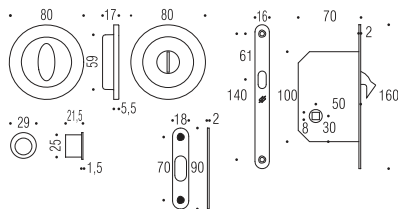

Spessore porta da 40 a 52mm
Door thickness from 40 to 52mm

Materiale: Ottone
Material: Brass



OPEN

ID 211 Design: TEAM 3

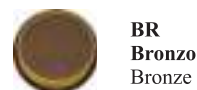

Kit per porta scorrevole composto da due maniglie ad incasso e maniglia di trascinamento.
Sliding Doors Kit composed of two groove handles and flush handle.

Kit per porta scorrevole composto da due maniglie ad incasso con dispositivo di chiusura a nottolino, maniglia di trascinamento e serratura (E 50mm) a gancio dotata di contropiastra in acciaio inox.
Sliding Doors Kit composed of two groove handles with thumb turn from one side, flush handle and stainless-steel mortise hook lock (E 50mm) with striking plate.

Kit per porta scorrevole composto da due maniglie ad incasso con dispositivo di chiusura a nottolino e maniglia di trascinamento
Sliding Doors Kit composed of two groove handles and flush handles with thumb turn and flush handle.

ID 211



ID 211 LK

con serratura
with lock



ID 211 BZG

senza serratura
without lock



HPS - OM - CR - CM - VL - VM
GL - GM - NI - BR - NM - BI

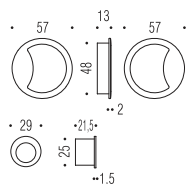

HPS - OM - CR - CM - VL - VM
GL - GM - NI - BR - NM - BI

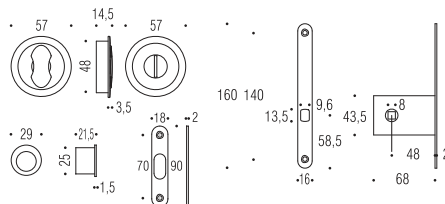

HPS - OM - CR - CM - VL - VM
GL - GM - NI - BR - NM - BI

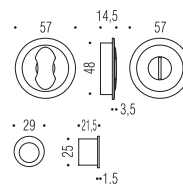

Spessore porta da 40 a 52mm
Door thickness from 40 to 52mm

Materiale: Ottone
Material: Brass



Spessore porta da 40 a 52mm
Door thickness from 40 to 52mm

Materiale: Ottone
Material: Brass



CD 111 - CD 211

Design:
Colombo Design



OL
Oroplus



CM
Cromat
Matt chrome



OM
Oromat
Matt gold



BR
Bronzo
Bronze



CR
Cromo
Chrome

CD 111

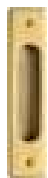

OL - OM

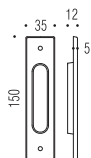

CD 111 CF



OL - OM

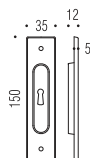

CD 211



OL - OM - CR - CM - BR

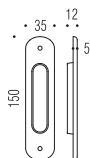

CD 211 CF



OL - OM - CR - CM - BR

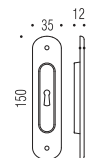

Misura fresata 25 x 90 x 8mm
Milling size 25 x 90 x 8mm

Materiale: Ottone
Material: Brass



CD311-CD511

Design:
Colombo Design



OL
Oroplus



GL
Grafite
Graphite



BA
Bronzo antico
Antique bronze



OM
Oromat
Matt gold



GM
Grafite Mat
Matt graphite



OA
Ottone antico
Antique brass



CR
Cromo
Chrome



NI
Nikelmat
Matt nickel



NM RAL 9005
Neromat
Matt Black



CM
Cromat
Matt chrome



BR
Bronzo
Bronze



BI RAL 9016
Biancomat
Matt White

CD 311



OL - CR - CM - NI

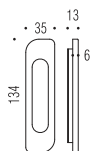

CD 311 CF



OL - CR - CM - NI

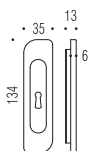

CD 511



HPS - OM - CR - CM - GL - GM
NI - BR - BA - OA - NM - BI

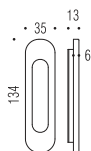

CD 511 CF



HPS - OM - CR - CM - GL - GM
NI - BR - BA - OA - NM - BI

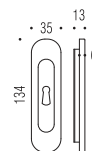

Misura fresata 28 x 113 x 8mm
Milling size 28 x 113 x 8mm

Materiale: Ottone
Material: Brass



CB111

Design:
Carlo Bartoli



OL
Oroplus



CM
Cromat
Matt chrome

CB 111



OL - CM

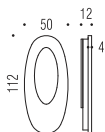

CB 111 CF



OL - CM

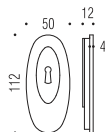

Misura fresata 34 x 105 x 10mm
Milling size 34 x 105 x 10mm

Materiale: Cromall®
Material: Cromall®



ID4111

Design:
Colombo Design



OL
Oroplus



VL
Vintage



NI
Nikelmat
Matt nickel



OM
Oromat
Matt gold



VM
Vintage mat



NM RAL 9005
Neromat
Matt Black



CR
Cromo
Chrome



GL
Grafite
Graphite



BI RAL 9016
Biancomat
Matt White



CM
Cromat
Matt chrome



GM
Grafite Mat
Matt graphite

ID 411

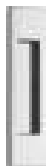

ID 411 CF

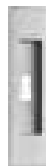

OL - OM - CR - CM - VL - VM
GL - GM - NI - NM - BI

OL - OM - CR - CM - VL - VM
GL - GM - NI - NM - BI

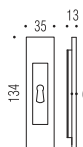
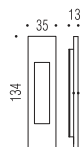

Misura fresata 28 x 113 x 8mm
Milling size 28 x 113 x 8mm

Materiale: Ottone
Material: Brass

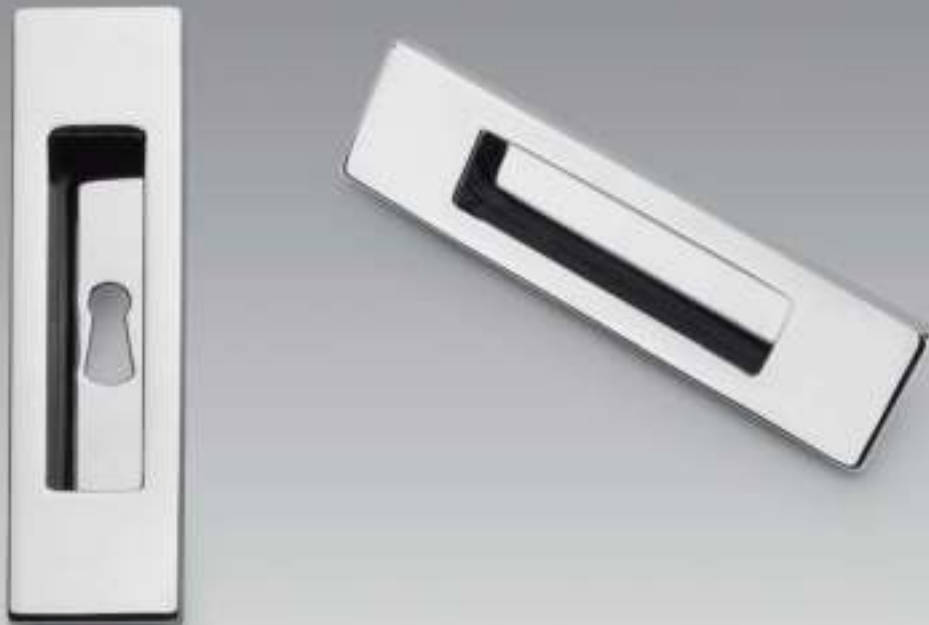

LC111

Design:
Luca Colombo



CR
Cromo
Chrome



CM
Cromat
Matt chrome

LC 111



CR - CM

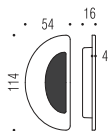

LC 111 CF



CR - CM

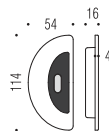

Misura fresata 38 x 98 x 13mm
Milling size 38 x 98 x 13mm

Materiale: Cromall®
Material: Cromall®



2021 EDITION

Programma blindate

Armored door program

MADE IN ITALY

MOSTRINE

ROSE
PLATES

Design:
Colombo Design



HPS
Zirconium Gold



CR
Cromo
Chrome



BR
Bronzo
Bronze



OL
Oroplus



CM
Cromat
Matt chrome



NM RAL 9005
Neromat
Matt Black



OM
Oromat
Matt gold



NI
Nikelmat
Matt nickel

Rosetta con sottorosetta in nylon
compresa di 5 viti di fissaggio.
Brass rose supplied with nylon
underconstruction and 5 fixing screws.

Rosetta con sottorosetta in nylon per
defender ø50mm compresa di 5 viti di
fissaggio (non adatto per montaggio
con SR73 WP).
Brass rose supplied with nylon
underconstruction for defender ø50mm
and 5 fixing screws (not suitable for
SR73 WP).

Placca interasse 85mm con sottoplacca
in nylon compresa di 5 viti di fissaggio
(utilizzabile solo con inserti PB06
e PB07).
Brass plate 85 mm distance, supplied with
nylon underconstruction and 5 fixing screws
(use only with underconstruction PB06
and PB07).

Placca interasse 93mm con sottoplacca
in nylon compresa di 5 viti di fissaggio
(utilizzabile solo con inserti PB05
e PB08).
Brass plate 93 mm distance, supplied with
nylon underconstruction and 5 fixing screws
(use only with underconstruction PB05
and PB08).

PB 01



HPS - OL - OM - CR - CM - NI - BR - NM

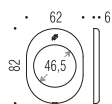

PB 01 DG



HPS - OL - OM - CR - CM - NI - BR - NM

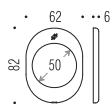

PB 02



HPS - OL - OM - CR - CM - NI - BR - NM

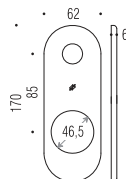

PB 02 Y



HPS - OL - OM - CR - CM - NI - BR - NM

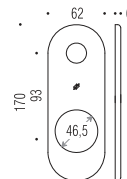

Materiale: Ottone
Material: Brass

• FIDUCIA GARANTITA 30 ANNI •
30
• 30 YEARS WARRANTY •

• FIDUCIA GARANTITA 10 ANNI •
10
• 10 YEARS WARRANTY •



MOSTRINE

ROSE
PLATES

Design:
Colombo Design



CR
Cromo
Chrome



CM
Cromat
Matt chrome



GM
Grafite Mat
Matt graphite

Rosetta quadrata con sottorosetta in nylon compresa di 5 viti di fissaggio.
Square brass rose supplied with nylon underconstruction and 5 fixing screws.

Rosetta quadrata con sottorosetta in nylon per defender ø50mm compresa di 5 viti di fissaggio (non adatto per montaggio con SR73 WP).
Square brass rose supplied with nylon underconstruction for defender ø50mm and 5 fixing screws (not suitable for SR73 WP).

Placca quadrata interasse 85mm con sottoplaeca in nylon compresa di 5 viti di fissaggio (utilizzabile solo con inserti PB06 e PB07).
Square brass plate 85 mm distance, supplied with nylon underconstruction and 5 fixing screws (use only with underconstruction PB06 and PB07).

Placca quadrata interasse 93mm con sottoplaeca in nylon compresa di 5 viti di fissaggio (utilizzabile solo con inserti PB05 e PB08).
Brass plate 93 mm distance, supplied with nylon underconstruction and 5 fixing screws (use only with underconstruction PB05 and PB08).

PB 01 Q



CR - CM - GM

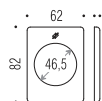

PB 01 DG Q



CR - CM - GM

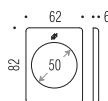

PB 02 Q



CR - CM - GM

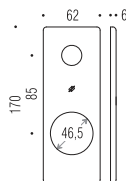

PB 02 Y Q



CR - CM - GM

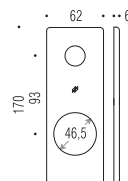

Materiale: Ottone
Material: Brass

FRUITURA GARANTITA 30 ANNI
30
FINISHING 30 YEARS WARRANTY

FRUITURA GARANTITA 10 ANNI
10
FINISHING 10 YEARS WARRANTY



INSERTI

UNIVERSAL
UNDERCONSTRUCTIONS

Design:
Colombo Design



NE
Nero
Black

**Inserto maniglia
(possibilità montaggio con
molla Ø45 mm).**
Underconstruction for level
handle rose (Ø45mm spring
installation possible).

**Inserto limitatore
d'apertura.**
Underconstruction for
opening limiting device.

**Inserto per cilindro
con pomolo.**
Underconstruction for
knob cylinder.

**Inserto doppia mappa
universale compreso
di copritoppa.**
Underconstruction for double
ward universal key with key
cover.

**Inserto doppia mappa
concavo universale
compreso di copritoppa.**
Underconstruction for double
ward universal key with key
cover.

Inserto foro yale.
Underconstruction for yale
key hole.

PB 03

PB 04

PB 05

PB 06

PB 07

PB 08



NE

NE

NE

NE

NE

NE

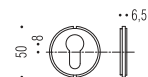
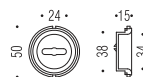
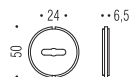
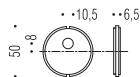
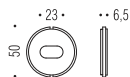
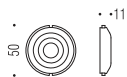

Materiale: Nylon
Material: Nylon



POMOLINI

KNOB
SETS

Design:
Colombo Design



HPS
Zirconium Gold



CR
Cromat
Chrome



NI
Nikelmat
Matt nickel



OL
Oroplus



CM
Cromat
Matt chrome



BR
Bronzo
Bronze



OM
Oromat
Matt gold



GM
Grafite Mat
Matt graphite



NM RAL 9005
Neromat
Matt Black

Pomolino Ø35mm per limitatore
d'apertura (e/o per cilindro)
cava interna quadro 8mm - Ø9mm.
Knob set Ø35mm for opening limiting
device (also for cylinder) spindle
8mm - thread 9mm.

PB 09



HPS - OL - OM - CR - CM - NI - BR - NM

Pomolino quadrato per limitatore
d'apertura (e/o per cilindro)
cava interna quadro 8mm - Ø9mm.
Square knob set for opening limiting
device (also for cylinder) spindle
8mm - thread 9mm.

PB 09 Q



CR - CM - GM

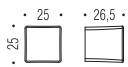
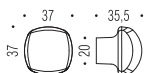

Materiale: Ottone (PB 09) - Cromall® (PB 09 Q)
Material: Brass (PB 09) - Cromall® (PB 09 Q)

FINITURA GARANTITA 30 ANNI
30
FINISHING 30 YEARS WARRANTY

FINITURA GARANTITA 10 ANNI
10
FINISHING 10 YEARS WARRANTY



KIT SR

Design:
Colombo Design



HPS
Zirconium Gold



BR
Bronzo
Bronze



CR
Cromo
Chrome



CM
Cromat
Matt chrome

Bocchetta di protezione per cilindro
Interasse 38mm. Viti M6x80 TPS+
Escursione cilindro da 8mm a 13mm.
Piastrina rotante ingresso chiave in
acciaio da cementazione al manganese.
Escutcheons cylinder protection
Centre 38mm. Screws 6MA
Cylinder regulation from 8÷13mm.
Key protecting plate magnesium tempered.

Bocchetta di protezione per cilindro
Interasse 38mm. Viti M6x80 TPS+
Escursione cilindro da 8mm a 13mm.
Piastrina rotante ingresso chiave in
acciaio da cementazione al manganese.
Escutcheons cylinder protection
Centre 38mm. Screws 6MA
Cylinder regulation from 8÷13mm.
Key protecting plate magnesium tempered.

KIT SR 73 WP

KIT SR 93 WP



HPS - CR - CM - BR

CR - CM

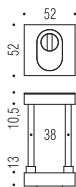
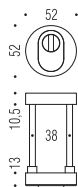

Materiale: Ottone/Acciaio
Material: Brass/Steel

30
FRUITURA GARANTITA 30 ANNI
PICKING 30 YEARS WARRANTY

10
FRUITURA GARANTITA 10 ANNI
PICKING 10 YEARS WARRANTY



2021 EDITION

Complementi

Complements

MADE IN ITALY

DKZERO

Design:
R&D Colombo Design



OL
Oroplus



CM
Cromat
Matt chrome



NM RAL 9005
Neromat
Matt Black



OM
Oromat
Matt gold



GM
Grafite Mat
Matt graphite



BI RAL 9016
Biancomat
Matt White



CR
Cromo
Chrome



VM
Vintage mat

Nasce DK ZERO. Un innovativo sistema per finestra Dreh-kipp quasi ad “impatto zero”, che consente di ridurre al minimo l’ingombro della rosetta DK. DK ZERO è di semplice installazione (è sufficiente un foro di diametro 20mm), adatto all’utilizzo su infissi dotati di microventilazione e adattabile a molteplici modelli e finiture della collezione Colombo Design.

DK ZERO is born. An innovative almost zero impact Dreh-kipp window system, which allows you to minimize the encumbrance of the DK rosette. DK ZERO is easy to install (a 20mm diameter hole is enough), suitable for use on window fixtures equipped with micro-ventilation and adaptable to several models and finishes from Colombo Design collection.

AMA
MF12 DK0/SM

DEA
FF22 DK0/SM

GIRA
JM12 DK0/SM

ISY
BL12 DK0/SM

ROBOT
CD42 DK0/SM

ROBOTRE
CD92 DK0/SM



CR - CM - GM

CR - CM

OL - CR - CM - VM

CR - CM

OL - CR - CM - NM - BI

OL - OM - CR - CM

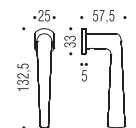
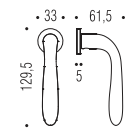
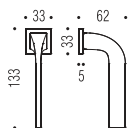
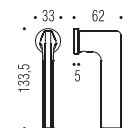
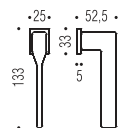
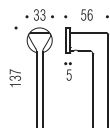

**Materiale: Ottone (Ama - Dea - Gira - Isy)
Cromall® (Robot - Robotre)**
Material: Brass (Ama - Dea - Gira - Isy)
Cromall® (Robot - Robotre)



DKZERO

UNI EN 13126-3

Certificazione di durabilità garantita per minimo 25.000 cicli, ciascuno con sequenza: 0-90°-180°-90°-0°
durability certification guaranteed for a minimum of 25.000 cycles, each one with 0-90°-180°-90°-0° sequence.



posizione 0°
position 0°



rotazione 45°
spin 45°



**rotazione 90°
apertura finestra**
spin 90° to open window



rotazione 135°
spin 135°



**rotazione 180°
anta ribalta**
spin 180° for vertical partial opening



DKZERO

Design:
R&D Colombo Design



OL
Oroplus



CM
Cromat
Matt chrome



NM RAL 9005
Neromat
Matt Black



OM
Oromat
Matt gold



GM
Grafite Mat
Matt graphite



BI RAL 9016
Biancomat
Matt White



CR
Cromo
Chrome



VM
Vintage mat

Nasce DK ZERO. Un innovativo sistema per finestra Dreh-kipp quasi ad “impatto zero”, che consente di ridurre al minimo l’ingombro della rosetta DK. DK ZERO è di semplice installazione (è sufficiente un foro di diametro 20mm), adatto all’utilizzo su infissi dotati di microventilazione e adattabile a molteplici modelli e finiture della collezione Colombo Design.

DK ZERO is born. An innovative almost zero impact Dreh-kipp window system, which allows you to minimize the encumbrance of the DK rosettes. DK ZERO is easy to install (a 20mm diameter hole is enough), suitable for use on window fixtures equipped with micro-ventilation and adaptable to several models and finishes from Colombo Design collection.

ROBOQUATTRO
ID42 DK0/SM



OL - OM - CR - CM

ROBOQUATTROS
ID52 DK0/SM



CR - CM - VM

ROBOCINQUE
ID62 DK0/SM



OL - CR - CM - NM - BI

ROBOCINQUES
ID72 DK0/SM



CR - CM - GM - NM - BI

VIOLA
AR22 DK0/SM



CR - CM

ZELDA
MM12 DK0/SM



CR - CM

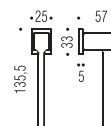
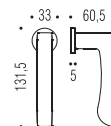
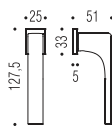
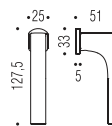
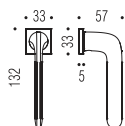
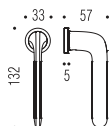

Materiale: Ottone (Viola - Zeldà)
Cromall® (Roboquattro - RoboquattroS - Robocinque - RobocinqueS)
Material: Brass (Viola - Zeldà)
Cromall® (Roboquattro - RoboquattroS - Robocinque - RobocinqueS)



DKZERO

UNI EN 13126-3

Certificazione di durabilità garantita per minimo 25.000 cicli, ciascuno con sequenza: 0-90°-180°-90°-0°
durability certification guaranteed for a minimum of 25.000 cycles, each one with 0-90°-180°-90°-0° sequence.



posizione 0°
position 0°



rotazione 45°
spin 45°



rotazione 90°
apertura finestra
spin 90° to open window



rotazione 135°
spin 135°



rotazione 180°
anta ribalta
spin 180° for vertical partial opening



DISPOSITIVI DI SICUREZZA

WINDOWS
SECURITY SETS



OL
Oroplus



CR
Cromo
Chrome



CM
Cromat
Matt chrome

Maniglia DK di Sicurezza Robot con dispositivo a pulsante di sicurezza, con movimento XDK40D incluso. Quadro 7x40. Carico di rottura 40 N 'm
Button-locked security Dreh-kipp DK window handle set. XDK40D mechanism included.
Spindle 7x40.
Breaking load 40 N 'm

Maniglia DK di Sicurezza Robotre con dispositivo a pulsante di sicurezza, con movimento XDK40D incluso. Quadro 7x40. Carico di rottura 40 N 'm
Button-locked security Dreh-kipp DK window handle set. XDK40D mechanism included.
Spindle 7x40.
Breaking load 40 N 'm

Maniglia DK di Sicurezza Roboquattro con dispositivo a pulsante di sicurezza, con movimento XDK40D incluso. Quadro 7x40. Carico di rottura 40 N 'm
Button-locked security Dreh-kipp DK window handle set. XDK40D mechanism included.
Spindle 7x40.
Breaking load 40 N 'm

Maniglia DK di Sicurezza RoboquattroS con dispositivo a pulsante di sicurezza, con movimento XDK40D incluso. Quadro 7x40. Carico di rottura 40 N 'm
Button-locked security Dreh-kipp DK window handle set. XDK40D mechanism included.
Spindle 7x40.
Breaking load 40 N 'm

Maniglia DK di Sicurezza Robocinq con dispositivo a pulsante di sicurezza, con movimento XDK40D incluso. Quadro 7x40. Carico di rottura 40 N 'm
Button-locked security Dreh-kipp DK window handle set. XDK40D mechanism included.
Spindle 7x40.
Breaking load 40 N 'm

Maniglia DK di Sicurezza RobocinqS con dispositivo a pulsante di sicurezza, con movimento XDK40D incluso. Quadro 7x40. Carico di rottura 40 N 'm
Button-locked security Dreh-kipp DK window handle set. XDK40D mechanism included.
Spindle 7x40.
Breaking load 40 N 'm

CD 42 DK Z

CD 92 DK Z

ID 42 DK Z

ID 52 DK Z

ID 62 DK Z

ID 72 DK Z



OL - CR - CM

OL - CR - CM

OL - CR - CM

CR - CM

OL - CR - CM

CR - CM

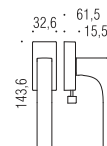
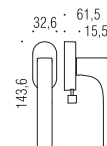
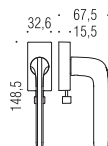
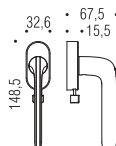
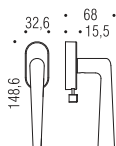
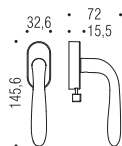

Material: Cromall®
Material: Cromall®

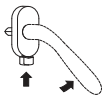

**premere
pulsante**
press button

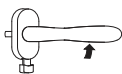

**rotazione 90°
apertura finestra**
spin 90° to open
window

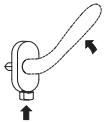

**premere
pulsante**
press button

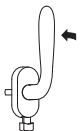

**rotazione 90°
anta ribalta**
spin 90° for vertical
partial opening

DISPOSITIVI ANTIEFFRAZIONE

WINDOWS SECURITY SETS



HPS
Zirconium Gold



HPS/1
Zirconium stainless-steel



NI
Nikelmat
Matt nickel



OL
Oroplus



CR
Cromo
Chrome



BR
Bronzo
Bronze



OM
Oromat
Matt gold



CM
Cromat
Matt chrome

UNI EN 1627:2011

Dispositivo con sistema di bloccaggio a chiave (cilindro KA stessa cifratura) per antieffrazione, adatto a tutti i modelli di maniglie con movimento DK (DK 40 D) incluso. Quadro 7x40.

Carico di rottura 100 N·m

Key-locked security DK window handle set (KA cylinder same key code) suitable for all handles. DK mechanism included (DK 40 D). Spindle 7x40. Breaking load 100 N·m

Dispositivo a pulsante di sicurezza, adatto a tutti i modelli di maniglie con movimento DK (DK Q8 L) incluso. Quadro 7x40. Carico di rottura 60 N·m

button-locked security DK window handle set suitable for all handles. DK mechanism included (DK Q8 L). Spindle 7x40. Breaking load 60 N·m

Dispositivo a pulsante di sicurezza quadrato, adatto a tutti i modelli di maniglie con movimento DK (DK Q8 L) incluso. Quadro 7x40.

Carico di rottura 60 N·m

Button-locked security DK window handle set suitable for all handles. DK mechanism included (DK Q8 L). Spindle 7x40. Breaking load 60 N·m

CD 02 DK LOCK

CD 02 DK Z

CD 02 DK Z/Q



HPS - OL - CR - CM

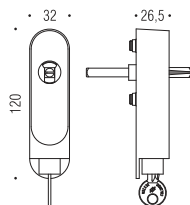

HPS - OL - OM - HPS/1
CR - CM - NI - BR

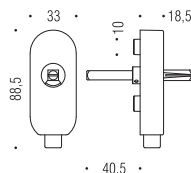

CR - CM

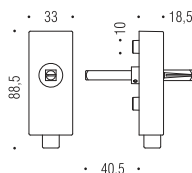

Materiale: Ottone/Acciaio (DK LOCK)
Cromall®/Acciaio (DK Z - DK Z/Q)
Material: Brass/Steel (DK Z LOCK)
Cromall®/Steel (DK Z - DK Z/Q)

FRITTURA GARANTITA 30 ANNI
30
FRITTURA GARANTITA 30 ANNI

FRITTURA GARANTITA 10 ANNI
10
FRITTURA GARANTITA 10 ANNI



**premere chiave
per bloccare
serratura**
press key to block
lock



**maniglia
sbloccata**
unblocked
handle

**ruotare chiave
per sbloccare serratura**
rotate key in order
to unblock lock



**rotazione 90°
apertura finestra**
spin 90° to open
window

**premere chiave
per bloccare serratura**
press key to block
lock



**premere
pulsante**
press button



**rotazione 90°
apertura finestra**
spin 90° to open
window



**premere
pulsante**
press button



**rotazione 90°
anta ribalta**
spin 90° for vertical
partial opening



FERMAPORTA

DOOR
STOPPERS



OL
Oroplus



GL
Grafite
Graphite



NI
Nikelmat
Matt nickel



NM RAL 9005
Neromat
Matt Black



OM
Oromat
Matt gold



GM
Grafite Mat
Matt graphite



BR
Bronzo
Bronze



BI RAL 9016
Biancomat
Matt White



CR
Cromo
Chrome



VL
Vintage



BA
Bronzo antico
Antique bronze



CM
Cromat
Matt chrome



VM
Vintage mat

Design: Colombo Design

Il gommino è di colore nero.
Black rubber ring.

CD 112



OL - OM - CR - CM - NI
BR - BA - NM - BI



Design: Colombo Design

Regolabile in altezza da 25 a 80mm,
il gommino superiore è di colore bianco
Adjustable from 25 to 80mm white rubber
tops.

CD 312



OL - CM

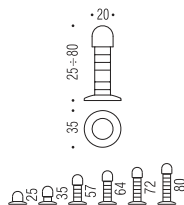

Design: Colombo Design

I gommini sono di colore nero.
Black rubber rings.

CD 412



OL - CR - CM - GM - NI



Design: Luca Colombo

La gomma è di colore nero.
Black rubber.

LC 112



OL - CR - CM - GL - GM
VL - VM - NM - BI

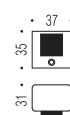

Materiale: Ottone (CD 312-CD412) - Ottone/Cromall® (CD 112) - Cromall® (LC 112)
Material: Brass (CD 312-CD412) - Brass/Cromall® (CD 112) - Cromall® (LC 112)

30
FUTURA GARANTITA 30 ANNI
FUTURE 30 YEARS WARRANTY

10
FUTURA GARANTITA 10 ANNI
FUTURE 10 YEARS WARRANTY



CHIAVI

KEYS



OL
Oroplus



CM
Cromat
Matt chrome



BA
Bronzo antico
Antique bronze



OM
Oromat
Matt gold



NI
Nikelmat
Matt nickel



OA
Ottone antico
Antique brass



CR
Cromo
Chrome



BR
Bronzo
Bronze



NM RAL 9005
Neromat
Matt Black

Design:
Alberto Meda

AM 14



OL-OM-CR-CM-NI-NM

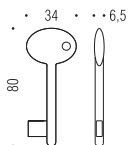

Design:
Angeletti Ruzza Design

AR 14



OL - BR - OA

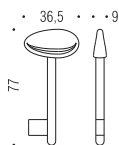

Design:
Carlo Bartoli

CB 24



OL - CM

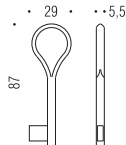

Design:
Colombo Design

CD 14



OL-OM-CR-CM-BA-OA

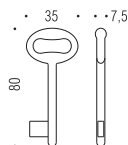

Design:
Luca Colombo

LC 14



OL - OM - CR - CM - NI

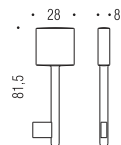

Design:
Luca Colombo

LC 24



CR - CM

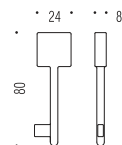

Materiale: Ottone
Material: Brass

FINITURA GARANTITA 30 ANNI
30
FINITURA 30 YEARS WARRANTY

FINITURA GARANTITA 10 ANNI
10
FINITURA 10 YEARS WARRANTY



NOTTOLINI

TOILET
ROSES



30
FIDUCIA GARANTITA 30 ANNI
30 YEARS WARRANTY

HPS
Zirconium
Gold



10
FIDUCIA GARANTITA 10 ANNI
10 YEARS WARRANTY

CR
Cromo
Chrome



30
FIDUCIA GARANTITA 30 ANNI
30 YEARS WARRANTY

GL
Grafite
Graphite



BA
Bronzo antico
Antique bronze



10
FIDUCIA GARANTITA 10 ANNI
10 YEARS WARRANTY

OL
Oroplus



10
FIDUCIA GARANTITA 10 ANNI
10 YEARS WARRANTY

CM
Cromat
Matt chrome



30
FIDUCIA GARANTITA 30 ANNI
30 YEARS WARRANTY

GM
Grafite Mat
Matt graphite



OA
Ottone antico
Antique brass



30
FIDUCIA GARANTITA 30 ANNI
30 YEARS WARRANTY

OM
Oromat
Matt gold



30
FIDUCIA GARANTITA 30 ANNI
30 YEARS WARRANTY

VL
Vintage



NI
Nikelmat
Matt nickel



10
FIDUCIA GARANTITA 10 ANNI
10 YEARS WARRANTY

NM RAL 9005
Neromat
Matt Black



30
FIDUCIA GARANTITA 30 ANNI
30 YEARS WARRANTY

HPS/1
Zirconium
stainless-steel



30
FIDUCIA GARANTITA 30 ANNI
30 YEARS WARRANTY

VM
Vintage mat



BR
Bronzo
Bronze



10
FIDUCIA GARANTITA 10 ANNI
10 YEARS WARRANTY

BI RAL 9016
Biancomat
Matt White

BT19 BZG 50x50



CD39 BZG Ø48



CD49 BZG G Ø50

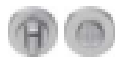

CD69 BZG G Ø50



CD79 BZG Ø50



DB19 BZG 63x50



FF19 BZG Ø50



HPS/1-OL-CR-CM
VL-VM

NI

HPS-OL-OM-HPS/1
CR-CM-NI-GL-GM
VL-VM-BR-NM-BI

HPS-OL-OM
CR-CM-NI-BR-BA
OA-NM-BI

OL-BR

OL-CR-BR

CR-CM



FF29 BZG 50x50



JP19 BZG Ø50



MF19 BZG Ø50



MM29 BZG 52x52



MR29 BZG G 51x51



PT19 BZG 52x52



SE19 BZG Ø50



CR-CM-GM
VL-VM-NM

CR-CM-GL-GM

CR-CM-GL-GM

CR-CM-GL-GM
NM-BI

CR-CM

OL-CR-CM-VL-VM

CR-CM-GL-GM

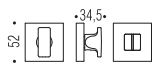
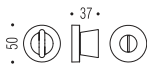

Material: Ottone/Cromall®
Material: Brass/Cromall®

30
FRUITURA GARANTITA 30 ANNI
FINISHING 30 YEARS WARRANTY

10
FRUITURA GARANTITA 10 ANNI
FINISHING 10 YEARS WARRANTY



LIBERO OCCUPATO

TOILET ROSES
WITH PRIVACY SNIBS



OL
Oroplus



GL
Grafite
Graphite



CR
Cromo
Chrome



GM
Grafite Mat
Matt graphite



CM
Cromat
Matt chrome

CD49 BZG H Ø50

CD69 BZG H Ø50

MM19 BZG H 52x52

MR19 BZG H 51x51

PT19 BZG H 52x52

SE19 BZG H Ø50



OL - CR - CM

OL - CR - CM

CR - CM

CR - CM

CR - CM

CR - CM - GL - GM

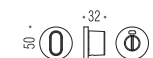
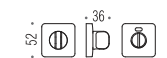

Materiale: Ottone/Cromall®
Material: Brass/Cromall®

30
FRUTURA GARANTITA 30 ANNI
CRACKING 30 YEARS WARRANTY

10
FRUTURA GARANTITA 10 ANNI
CRACKING 10 YEARS WARRANTY



2021 EDITION

Appenditutto

Coat hangers

MADE IN ITALY

ALIZÉ

AR 37 Design:
Angeletti Ruzza Design



CR
Cromo
Chrome

AR 37



CR

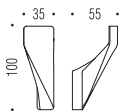

Materiale: Ottone
Material: Brass



BART

CB 67 Design:
Bartoli Design



CR
Cromo
Chrome

CB 67



CR

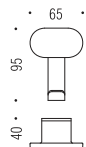

Materiale: Ottone/Cromall®
Material: Brass/Cromall®



BASIC

ID 17

ID 27 Design:
Colombo Design



CR
Cromo
Chrome

ID 17



CR



ID 27



CR



Materiale: Ottone (ID 17) - Cromall® (ID 27)
Material: Brass (ID 17) - Cromall® (ID 27)



BASIC Q

LC 97 Design:
Colombo Design



CR
Cromo
Chrome

CD 97



CR

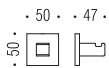

Materiale: Cromall®
Material: Cromall®

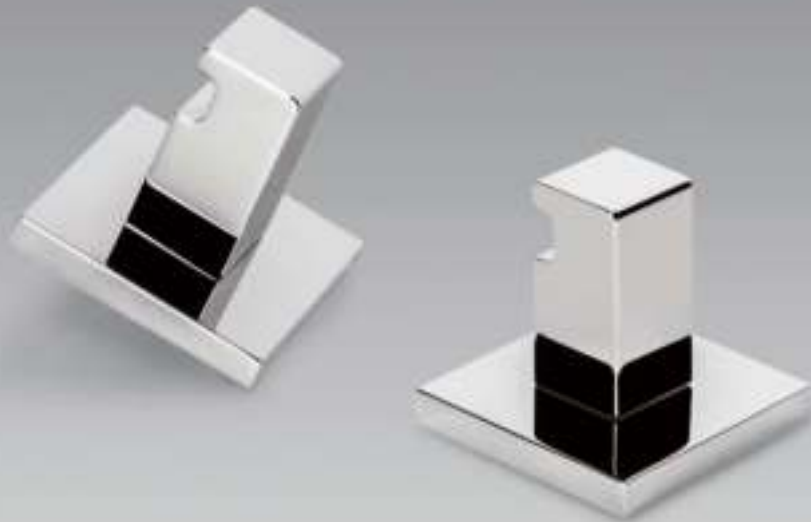

CLUB

CB 37 Design:
Carlo Bartoli



CR
Cromo
Chrome

CB 37



CR

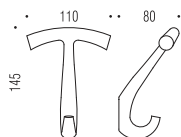

Materiale: Ottone
Material: Brass



FOREVER

LC 67 Design:
Luca Colombo



CR
Cromo
Chrome

LC 67



CR

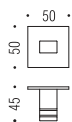



Fissaggio a muro e vetro con uno speciale nastro biadesivo in schiuma acrilica ad alte prestazioni (3M™ VHB™).
Wall and glass fixing with a special high performance double sided acrylic foam tape (3M™ VHB™).

Materiale: Ottone/Cromall®
Material: Brass/Cromall®

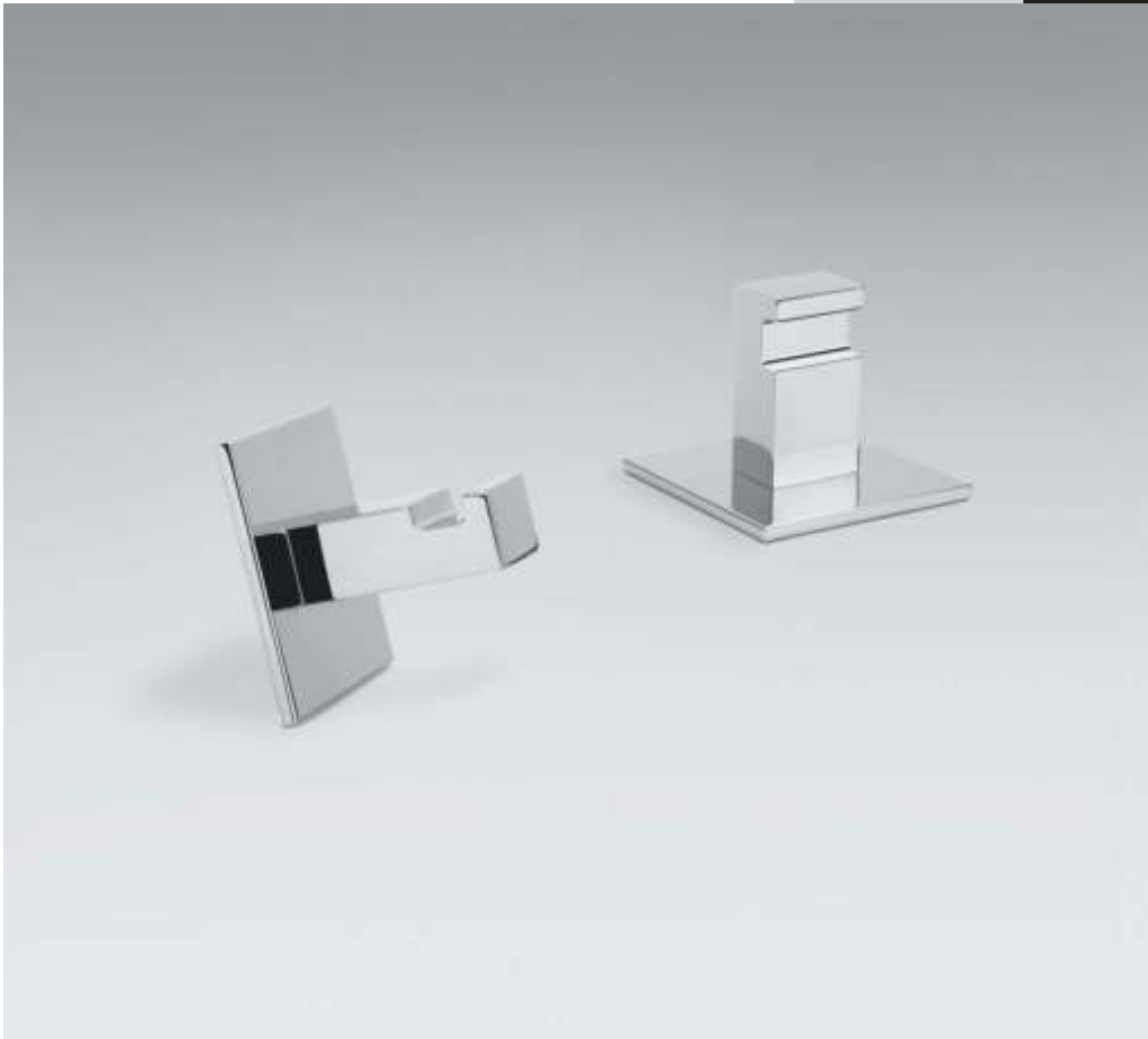

GOLF

AR 17 Design:
Angeletti Ruzza Design



OL
Oroplus



NI
Nikelmat
Matt nickel

AR 17



OL - NI

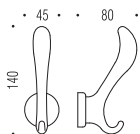

Materiale: Ottone
Material: Brass



HERMITAGE

LC 77

LC 87 Classic Line



HPS
Zirconium Gold



CR
Cromo
Chrome



OA
Ottone antico
Antique brass

LC 77

LC 87



HPS - CR - OA

HPS - CR - OA



Materiale: Ottone
Material: Brass



HOOK 1-2

AM 17

AM 27 Design:
Alberto Meda



CR
Cromo
Chrome

AM 17



CR

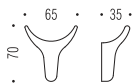

AM 27



CR

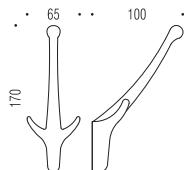

Materiale: Ottone
Material: Brass



KHALA

MH 17 Design:
Makio Hasuike



CR
Cromo
Chrome

MH 17



CR

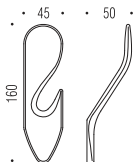

Materiale: Ottone
Material: Brass



LAND

CD 67

CD 77 Design:
TEAM 3



CR
Cromo
Chrome

CD 67



CR

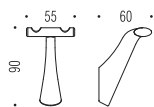

CD 77



CR

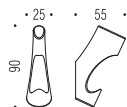

Materiale: Ottone
Material: Brass



LINK

AR 27 Design:
Angeletti Ruzza Design



CR
Cromo
Chrome

AR 27



CR

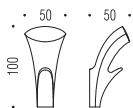

Materiale: Ottone
Material: Brass

FINITURA GARANTITA 10 ANNI
10
LACCHERIE 10 YEARS WARRANTY



LOOK

LC 27

LC 37 Design:
Luca Colombo



CR
Cromo
Chrome



BI
Biancomat
Matt white

LC 27

LC 37



CR - BI

CR - BI

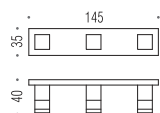

Materiale: Ottone (LC 37) - Cromall® (LC 27)
Material: Brass (LC 37) - Cromall® (LC 27)

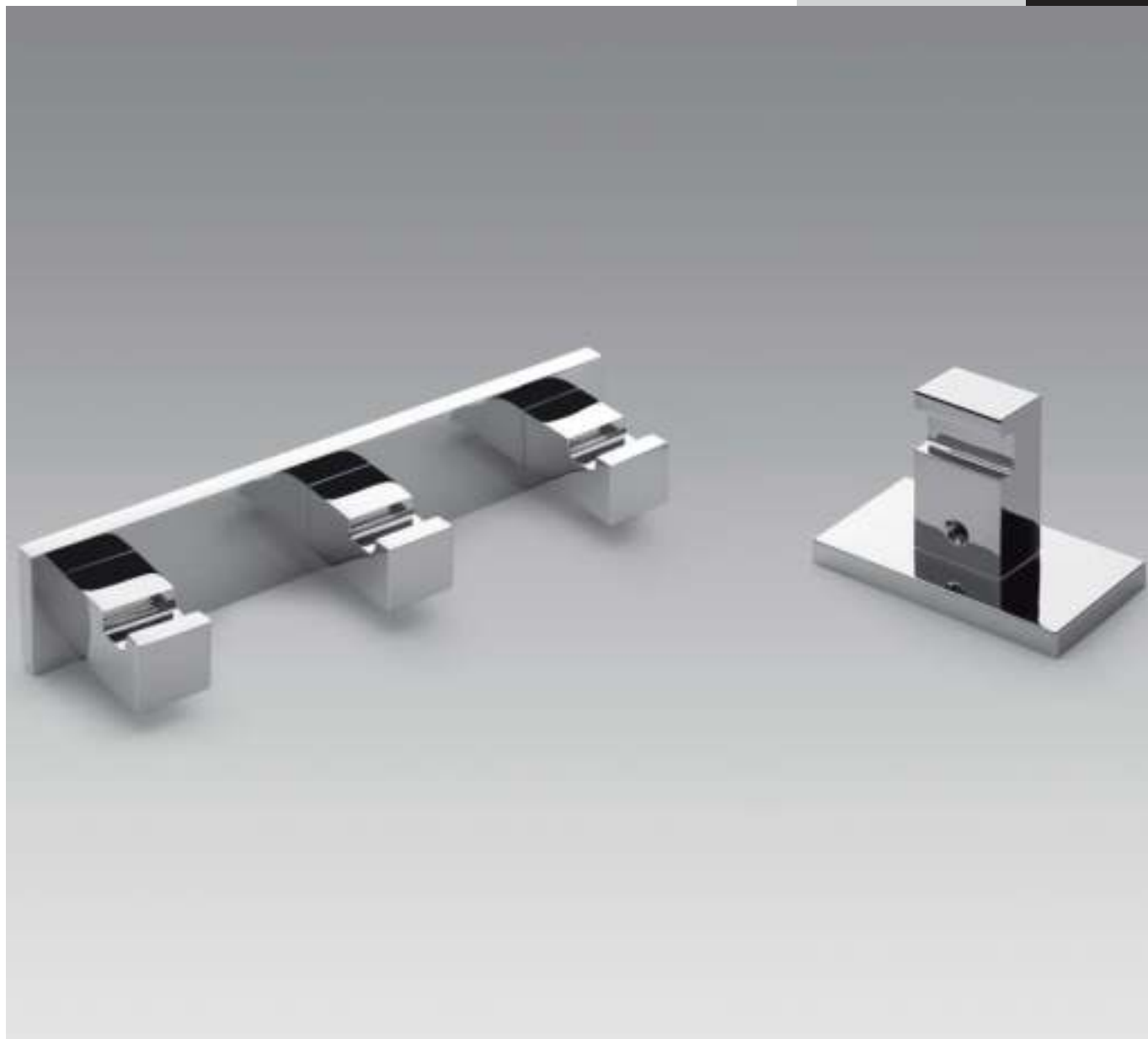

LULÙ

LC 47

LC 57 Design:
Luca Colombo



HPS
Zirconium Gold



CR
Cromo
Chrome

LC 47

LC 57



HPS - CR

HPS - CR

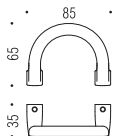

Materiale: Ottone
Material: Brass

FRUITURA GARANTITA 30 ANNI
30
FINISHING 30 YEARS WARRANTY

FRUITURA GARANTITA 10 ANNI
10
FINISHING 10 YEARS WARRANTY



MELÒ

RA 17 Design:
Ambrogio Rossari



CR
Cromo
Chrome

RA 17



CR

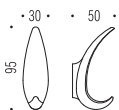

Materiale: Cromall®
Material: Cromall®



NORDIC

EB 17

EB 27

Design:
Efrem Bonacina e Giovanni Moro



CR
Cromo
Chrome

EB 17

EB 27



CR

CR

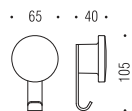
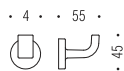

Materiale: Cromall®
Material: Cromall®



OVER

GM 17 Design:
Efrem Bonacina e Giovanni Moro



SS
Satinata
Satin

GM 17



SS

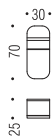

GM 17 V



SS





Fissaggio a muro e vetro con uno speciale nastro biadesivo in schiuma acrilica ad alte prestazioni (3M™ VHB™).

Wall and glass fixing with a special high performance double sided acrylic foam tape (3M™ VHB™).

Materiale: Acciaio Inox AISI 316 L
Material: AISI 316 L Inox stainless-steel



PLUS

PB 17 Design:
Piet Billekens



HPS
Zirconium Stainless-steel



CR
Cromo
Chrome

PB 17



HPS/1 - CR



Materiale: Ottone
Material: Brass

FINITURA GARANTITA 30 ANNI
30
FINITURA 30 YEARS WARRANTY

FINITURA GARANTITA 10 ANNI
10
FINITURA 10 YEARS WARRANTY



POLO

LC 17 Design:
Luca Colombo



CR
Cromo
Chrome

LC 17



CR

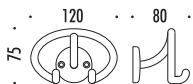

Materiale: Cromall®
Material: Cromall®



PORTOFINO

CD 87

CD 97 Classic Line



CR
Cromo
Chrome

CD 87

CD 97



CR

CR

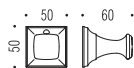

Materiale: Ottone
Material: Brass



ROAD

MO17 Design: **mama**DESIGN



CR
Cromo
Chrome

MO 17



CR



Materiale: Ottone
Material: Brass



TIME

CD 17

CD 37

CD 27

CD 47

CD 57

Design:
Colombo Design



CR
Cromo
Chrome

CD 17

CD 27

CD 37

CD 47

CD 57



CR

CR

CR

CR

CR

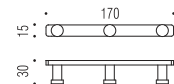
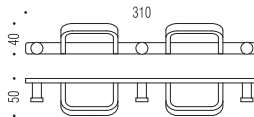
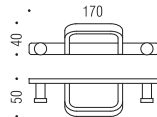
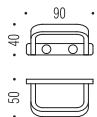

Materiale: Ottone
Material: Brass



TRIO

CB 17 Design:
Carlo Bartoli



CR
Cromo
Chrome

CB 17



CR

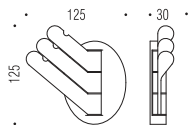

Materiale: Cromall®/Ottone
Material: Cromall®/Brass



